

2024/10

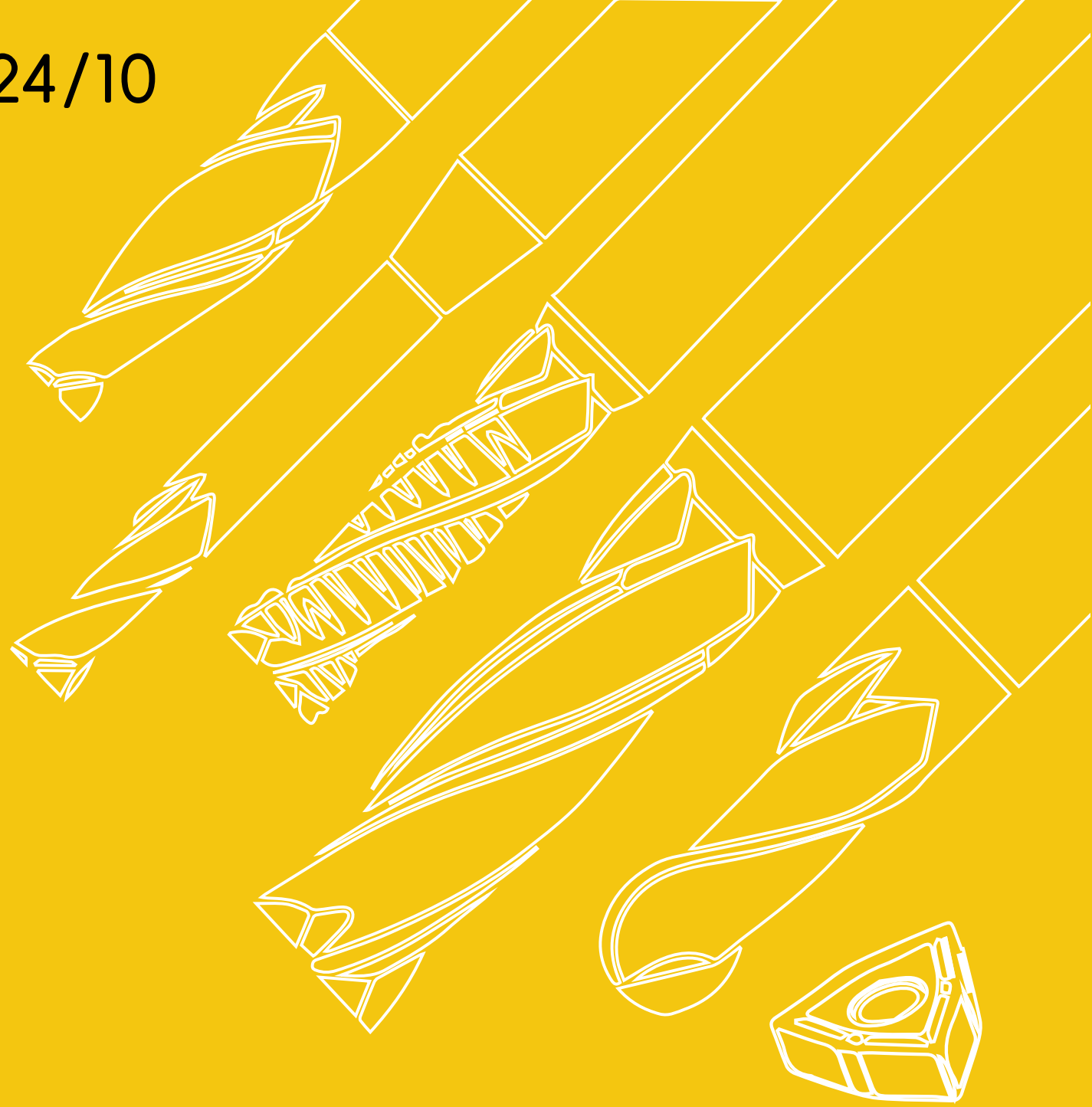

# 铣刀目录

**优木德精密技术(东莞)有限公司**

Youmude Precision Technology (Dongguan) Co., Ltd

**YOUMUDE**

YOUMUDE

YOUMUDE

目录 CONTENTS

钨钢镗刀, 槽刀



P01-11

钨钢涂层棒棒糖球型铣刀



P12

钨钢定心倒角刀



P13-14

钨钢上下倒角刀

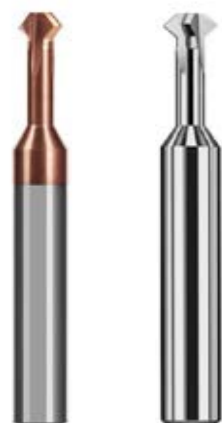

P15-16

钨钢三刃倒角刀



P17

钨钢内R铣刀



P18-19

钨钢中心钻



P20

钨钢螺纹铣刀



P21-45

钨钢铝用U槽铣刀



P48

目录 CONTENTS

钨钢铝用U槽铣刀



P47

钨钢钢用粗皮铣刀



P48

钨钢二刃铣刀



P49-50

钨钢小数点铣刀



P51-55

钨钢涂层微小径铣刀



P56

钨钢涂层微小径深沟铣刀



P57-58

钨钢铝用粗皮铣刀



P59-60

钨钢高硬立铣刀



P61-62

钨钢铝用球刀



P63-64

# 目录 CONTENTS

钨钢铝用T型圆弧铣刀



P65-66

钨钢涂层T型圆弧铣刀



P67-68

钨钢高硬球刀



P69-70

钨钢铝用铣刀



P71-72

钨钢高硬圆鼻铣刀



P73-74

钨钢涂层T型铣刀



P75

钨钢涂层燕尾铣刀



P76

钨钢铝用T型铣刀



P77

钨钢铝用燕尾铣刀



P78

# 目录 CONTENTS

钨钢微小径深沟球刀



P79-80

钨钢微小径球刀



P81

钨钢钻头



P83-88

刀柄



P89-96

数控刀片



P97-112

YUSMGR

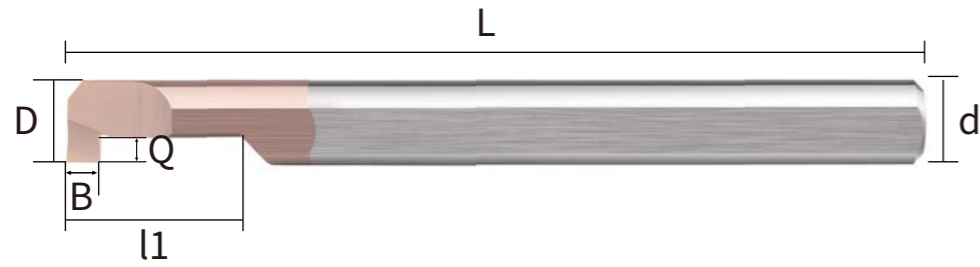

型号	刃径	宽度	深度	避空长度	柄径	总长
Code No.	D	B	Q	l1	d	L
YUSMGR-29050	2.9	0.5	0.8	10	4	50
YUSMGR-29075	2.9	0.75	0.8	10	4	50
YUSMGR-29100	2.9	1	0.8	10	4	50
YUSMGR-29150	2.9	1.5	0.8	10	4	50
YUSMGR-39050	3.9	0.5	1	10	4	50
YUSMGR-39080	3.9	0.8	1	10	4	50
YUSMGR-39100	3.9	1	1	10	4	50
YUSMGR-39150	3.9	1.5	1	10	4	50
YUSMGR-49100	4.9	1	1.5	10	5	50
YUSMGR-49120	4.9	1.2	1.5	10	5	50
YUSMGR-49150	4.9	1.5	1.5	10	5	50
YUSMGR-49200	4.9	2	2	10	5	50
YUSMGR-59100	5.9	1	2	15	6	50
YUSMGR-59150	5.9	1.5	2	15	6	50
YUSMGR-59200	5.9	2	2.5	15	6	50
YUSMGR-59250	5.9	2.5	2.5	15	6	50
YUSMGR-79150	7.9	1.5	2	20	8	60
YUSMGR-79200	7.9	2	2.5	20	8	60
YUSMGR-79250	7.9	2.5	3	20	8	60
YUSMGR-79300	7.9	3	3	20	8	60

YUSMKR

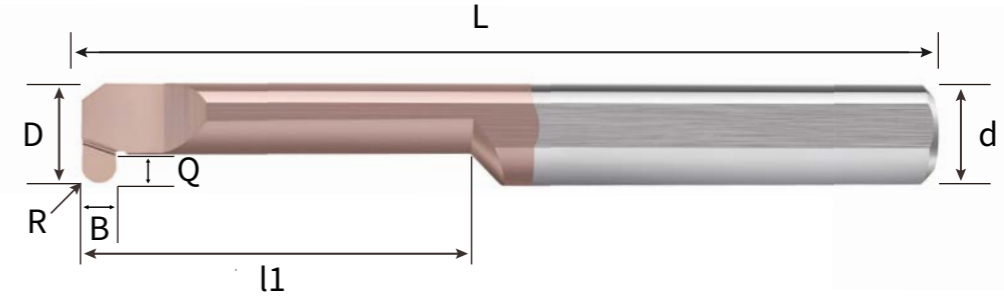

型号	刃径	R角半径	深度	避空长度	柄径	总长
Code No.	D	R	Q	l1	d	L
YUSMKR-3905010	3.9	0.5	1	10	4	50
YUSMKR-3905015	3.9	0.5	1	15	4	50
YUSMKR-3907510	3.9	0.75	1	10	4	50
YUSMKR-3907515	3.9	0.75	1	15	4	50
YUSMKR-4905015	4.9	0.5	1.2	15	5	50
YUSMKR-4905022	4.9	0.5	1.2	22	5	50
YUSMKR-4907515	4.9	0.75	1.2	15	5	50
YUSMKR-4907522	4.9	0.75	1.2	22	5	50
YUSMKR-4910015	4.9	1	1.3	15	5	50
YUSMKR-4910022	4.9	1	1.3	22	5	50
YUSMKR-5905015	5.9	0.5	1.6	15	6	50
YUSMKR-5905022	5.9	0.5	1.6	22	6	50
YUSMKR-5907515	5.9	0.75	1.6	15	6	50
YUSMKR-5907522	5.9	0.75	1.6	22	6	50
YUSMKR-5910015	5.9	1	1.6	15	6	50
YUSMKR-5910022	5.9	1	1.6	22	6	50
YUSMKR-7905022	7.9	0.5	2	22	8	60
YUSMKR-7907522	7.9	0.75	2	22	8	60
YUSMKR-7910022	7.9	1	2	22	8	60

可切削材料适用表 Applicable table for cutting materials

○ 非常合适 ○ 合适

碳素钢 carbon steel	合金钢 Alloy steel	预硬钢、淬硬钢 Prehardened steel, hardened steel				不锈钢 Stainless steel	铸铁 cast iron 球墨铸铁 Spheroidal graphite cast iron	铜合金 Copper alloy	铝合金 Aluminium alloy	铜合金 titanium alloy	耐热合金 Heat-resisting alloy
		~40HRC	~50HRC	~55HRC	~68HRC						
○	○	○	○	○	○		○	○	○	○	

Delivery 交货期 请咨询 Please ask Order 订货范例 Code No. YUSMGR-29050

可切削材料适用表 Applicable table for cutting materials

○ 非常合适 ○ 合适

碳素钢 carbon steel	合金钢 Alloy steel	预硬钢、淬硬钢 Prehardened steel, hardened steel				不锈钢 Stainless steel	铸铁 cast iron 球墨铸铁 Spheroidal graphite cast iron	铜合金 Copper alloy	铝合金 Aluminium alloy	铜合金 titanium alloy	耐热合金 Heat-resisting alloy
		~40HRC	~50HRC	~55HRC	~68HRC						
○	○	○	○	○	○		○	○	○	○	

Delivery 交货期 请咨询 Please ask Order 订货范例 Code No. YUSMKR-3905010

YUSMFR

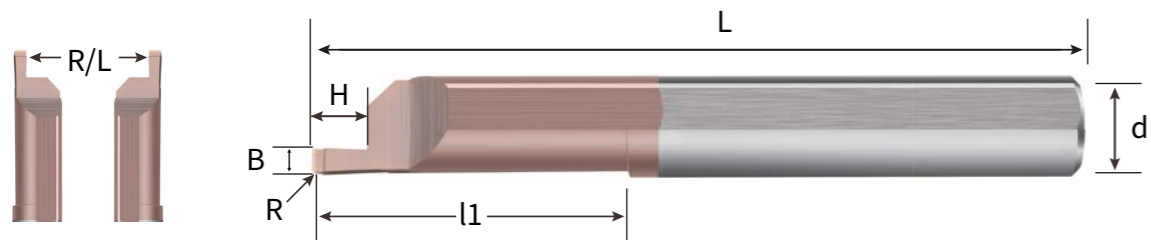

型号 Code No.	刃向 R/L	宽度 B	R角 R	深度 H	避空长度 l1	柄径 d	总长 L
YUSMFR-0510150	R	0.5	0.05	1	15	4	50
YUSMFR-07515150	R	0.75	0.05	1.5	15	4	50
YUSMFR-1015150	R	1	0.05	1.5	15	4	50
YUSMFR-1520150	R	1.5	0.05	2	15	4	50
YUSMFR-1020220	R	1	0.05	2	22	5	50
YUSMFR-1530220	R	1.5	0.05	3	22	5	50
YUSMFR-2040220	R	2	0.05	4	22	5	50
YUSMFR-0510200	R	0.5	0.05	1	20	6	50
YUSMFR-1020200	R	1	0.05	2	20	6	50
YUSMFR-1530200	R	1.5	0.05	3	20	6	50
YUSMFR-2040200	R	2	0.05	4	20	6	50
YUSMFR-1020250	R	1	0.05	2	25	8	60
YUSMFR-1530250	R	1.5	0.05	3	25	8	60
YUSMFR-2040250	R	2	0.05	4	25	8	60
YUSMFL-0510150	L	0.5	0.05	1	15	4	50
YUSMFL-07515150	L	0.75	0.05	1.5	15	4	50
YUSMFL-1015150	L	1	0.05	1.5	15	4	50
YUSMFL-1520150	L	1.5	0.05	2	15	4	50
YUSMFL-1020220	L	1	0.05	2	22	5	50
YUSMFL-1530220	L	1.5	0.05	3	22	5	50
YUSMFL-2040220	L	2	0.05	4	22	5	50
YUSMFL-0510200	L	0.5	0.05	1	20	6	50
YUSMFL-1020200	L	1	0.05	2	20	6	50
YUSMFL-1530200	L	1.5	0.05	3	20	6	50
YUSMFL-2040200	L	2	0.05	4	20	6	50
YUSMFL-1020250	L	1	0.05	2	25	8	60
YUSMFL-1530250	L	1.5	0.05	3	25	8	60
YUSMFL-2040250	L	2	0.05	4	25	8	60

YUSMZR

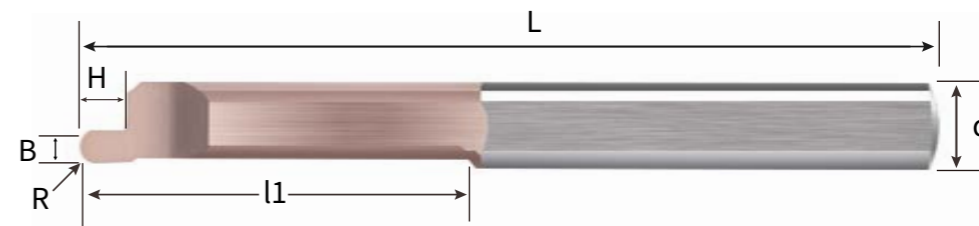

型号 Code No.	刃向 R/L	宽度 B	R角半径 R	深度 H	避空长度 l1	柄径 d	总长 L
YUSMZR-0512150	R	0.5	0.5	1.2	15	4	50
YUSMZR-07515150	R	0.75	0.5	1.5	15	4	50
YUSMZR-0512220	R	0.5	0.5	1.2	22	5	50
YUSMZR-07515220	R	0.75	0.5	1.5	22	5	50
YUSMZR-1025220	R	1	1	2.5	22	5	50
YUSMZR-0512220	R	0.5	0.5	1.2	22	6	50
YUSMZR-07515220	R	0.75	0.75	1.5	22	6	50
YUSMZR-1025220	R	1	1	2.5	22	6	50
YUSMZL-0512150	L	0.5	0.5	1.2	15	4	50
YUSMZL-07515150	L	0.75	0.5	1.5	15	4	50
YUSMZL-0512220	L	0.5	0.5	1.2	22	5	50
YUSMZL-07515220	L	0.75	0.5	1.5	22	5	50
YUSMZL-07525220	L	1	1	2.5	22	5	50
YUSMZL-0512220	L	0.5	0.5	1.2	22	6	50
YUSMZL-07515220	L	0.75	0.75	1.5	22	6	50
YUSMZL-1025220	L	1	1	2.5	22	6	50

可切削材料适用表 Applicable table for cutting materials

非常合适 合适

碳素钢 carbon steel	合金钢 Alloy steel	预硬钢、淬硬钢 Prehardened steel, hardened steel				不锈钢 Stainless steel	铸铁 cast iron 球墨铸铁 Spheroidal graphite cast iron	铜合金 Copper alloy	铝合金 Aluminium alloy	铜合金 titanium alloy	耐热合金 Heat-resisting alloy
		~40HRC	~50HRC	~55HRC	~68HRC						
○	○	○	○	○	○		○	○	○	○	

Delivery 交货期 请咨询 Please ask Order 订货范例 Code No. YUSMFR-0510150

可切削材料适用表 Applicable table for cutting materials

非常合适 合适

碳素钢 carbon steel	合金钢 Alloy steel	预硬钢、淬硬钢 Prehardened steel, hardened steel				不锈钢 Stainless steel	铸铁 cast iron 球墨铸铁 Spheroidal graphite cast iron	铜合金 Copper alloy	铝合金 Aluminium alloy	铜合金 titanium alloy	耐热合金 Heat-resisting alloy
		~40HRC	~50HRC	~55HRC	~68HRC						
○	○	○	○	○	○		○	○	○	○	

Delivery 交货期 请咨询 Please ask Order 订货范例 Code No. YUSMZR-0512150

YUSMTR

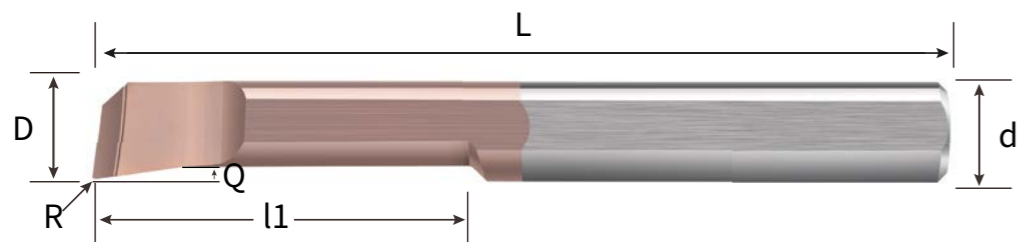

型号 Code No.	刃径 D	R角 R	切深 Q	避空长度 l1	柄径 d	总长 L
YUSMTR-S008013	0.8	0.05	0.1	3	4	50
YUSMTR-S0090153	0.9	0.05	0.15	3	4	50
YUSMTR-S0110154	1.1	0.05	0.15	4	4	50
YUSMTR-S0130155	1.3	0.05	0.15	5	4	50
YUSMTR-S015026	1.5	0.05	0.2	6	4	50
YUSMTR-S017027	1.7	0.05	0.2	7	4	50
YUSMTR-S01701027	1.7	0.1	0.2	7	4	50
YUSMTR-S019028	1.9	0.05	0.2	8	4	50
YUSMTR-S0190258	1.9	0.1	0.25	8	4	50
YUSMTR-S0240310	2.4	0.05	0.3	10	4	50
YUSMTR-S024010310	2.4	0.1	0.3	10	4	50
YUSMTR-S028038	2.8	0.05	0.3	8	4	50
YUSMTR-S0280312	2.8	0.05	0.3	12	4	50
YUSMTR-S0280315	2.8	0.05	0.3	15	4	50
YUSMTR-S02801038	2.8	0.1	0.3	8	4	50
YUSMTR-S028010310	2.8	0.1	0.3	10	4	50
YUSMTR-S028010312	2.8	0.1	0.3	12	4	50
YUSMTR-S028010315	2.8	0.1	0.3	15	4	50
YUSMTR-S028015038	2.8	0.15	0.3	8	4	50
YUSMTR-S0280150312	2.8	0.15	0.3	12	4	50
YUSMTR-S0280150315	2.8	0.15	0.3	15	4	50
YUSMTR-S02802038	2.8	0.2	0.3	8	4	50
YUSMTR-S028020315	2.8	0.2	0.3	15	4	50
YUSMTR-S03403515	3.4	0.05	0.35	15	4	50
YUSMTR-S0340103515	3.4	0.1	0.35	15	4	50
YUSMTR-S03401503515	3.4	0.15	0.35	15	4	50
YUSMTR-S0340203512	3.4	0.2	0.35	12	4	50
YUSMTR-S0340203515	3.4	0.2	0.35	15	4	50
YUSMTR-S0340203522	3.4	0.2	0.35	22	4	50
YUSMTR-S03904510	3.9	0.05	0.45	10	4	50
YUSMTR-S03904515	3.9	0.05	0.45	15	4	50
YUSMTR-S03904522	3.9	0.05	0.45	22	4	50
YUSMTR-S0390104510	3.9	0.1	0.45	10	4	50
YUSMTR-S0390104515	3.9	0.1	0.45	15	4	50
YUSMTR-S0390104522	3.9	0.1	0.45	22	4	50
YUSMTR-S03901504510	3.9	0.15	0.45	10	4	50
YUSMTR-S03901504515	3.9	0.15	0.45	15	4	50
YUSMTR-S03901504522	3.9	0.15	0.45	22	4	50
YUSMTR-S0390204510	3.9	0.2	0.45	10	4	50
YUSMTR-S0390204515	3.9	0.2	0.45	15	4	50

YUSMTR-S0390204522	3.9	0.2	0.45	22	4	50
YUSMTR-L0390204520	3.9	0.2	0.45	20	4	75
YUSMTR-XL0390204525	3.9	0.2	0.45	25	4	100
YUSMTR-S044020515	4.4	0.2	0.5	15	5	50
YUSMTR-S045020515	4.5	0.2	0.5	15	5	50
YUSMTR-S045020522	4.5	0.2	0.5	22	5	50
YUSMTR-S04905515	4.9	0	0.55	15	5	50
YUSMTR-S04905522	4.9	0	0.55	22	5	50
YUSMTR-S0490105515	4.9	0.1	0.55	15	5	50
YUSMTR-S0490105522	4.9	0.1	0.55	22	5	50
YUSMTR-S0490205515	4.9	0.2	0.55	15	5	50
YUSMTR-S0490205520	4.9	0.2	0.55	20	5	50
YUSMTR-S0490205522	4.9	0.2	0.55	22	5	50
YUSMTR-S0490205530	4.9	0.2	0.55	30	5	60
YUSMTR-L0490205525	4.9	0.2	0.55	25	5	75
YUSMTR-XL0490205530	4.9	0.2	0.55	30	5	100
YUSMTR-S0540206520	5.4	0.2	0.65	20	6	50
YUSMTR-S05906515	5.9	0.05	0.65	15	6	50
YUSMTR-S05906522	5.9	0.05	0.65	22	6	50
YUSMTR-S0590106515	5.9	0.1	0.65	15	6	50
YUSMTR-S0590106522	5.9	0.1	0.65	22	6	50
YUSMTR-S0590206515	5.9	0.2	0.65	15	6	50
YUSMTR-S0590206522	5.9	0.2	0.65	22	6	50
YUSMTR-S0590206530	5.9	0.2	0.65	30	6	60
YUSMTR-L0590206525	5.9	0.2	0.65	25	6	75
YUSMTR-XL0590206530	5.9	0.2	0.65	30	6	100
YUSMTR-S0590406515	5.9	0.4	0.65	15	6	50
YUSMTR-S0590406522	5.9	0.4	0.65	22	6	50
YUSMTR-S0690207522	6.9	0.2	0.75	22	8	60
YUSMTR-S0590207525	6.9	0.2	0.75	25	8	60
YUSMTR-S0590207530	6.9	0.2	0.75	30	8	60
YUSMTR-S0790108530	7.9	0.1	0.85	30	8	60
YUSMTR-S0790208522	7.9	0.2	0.85	22	8	60
YUSMTR-S0790208530	7.9	0.2	0.85	30	8	60
YUSMTR-L0790208530	7.9	0.2	0.85	30	8	100

可切削材料适用表 Applicable table for cutting materials

非常合适 合适

碳素钢 carbon steel	合金钢 Alloy steel	预硬钢、淬硬钢 Prehardened steel, hardened steel				不锈钢 Stainless steel	铸铁 cast iron 球墨铸铁 Spheroidal graphite cast iron	铜合金 Copper alloy	铝合金 Aluminium alloy	铜合金 titanium alloy	耐热合金 Heat-resisting alloy
		~40HRC	~50HRC	~55HRC	~68HRC						
○	○	○	○	○	○	○	○	○	○	○	



Delivery  
交货期



请咨询  
Please ask



Order  
订货范例

Code No.  
YUSMTR-S008013

YUSTR

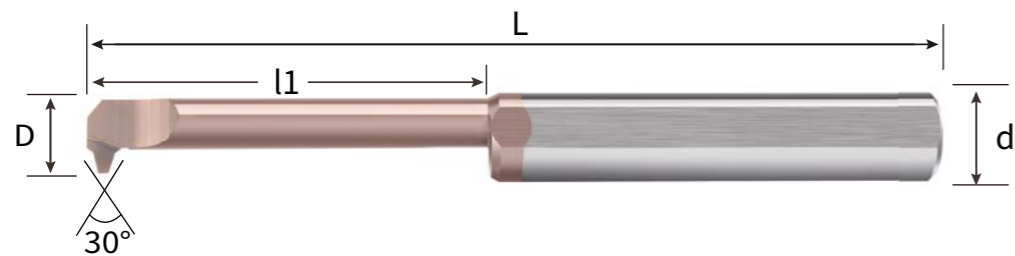

型号	刃径	角度	牙距	避空长度	柄径	总长
Code No.	D	G	S	l1	d	L
YUSTR-S15056	5.6	30	1.5	20	6	50
YUSTR-S20064	6.4	30	2	25	8	60
YUSTR-S30068	6.8	30	3	35	8	75
YUSTR-S20096	9.6	30	2	35	10	75
YUSTR-S40099	9.9	30	4	45	10	100
YUSTR-S50119	11.9	30	5	50	12	100

YUSMXR

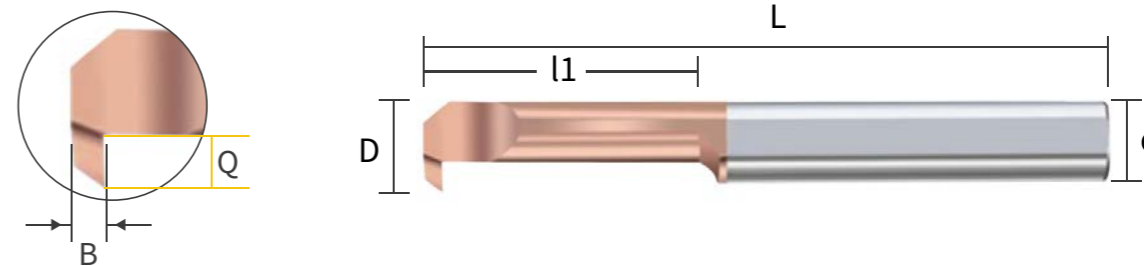

型号	刃径	R角	深度	宽度	避空长度	柄径	总长
Code No.	D	R	Q	B	l1	d	L
YUSMXR02810	2.8	0.1	0.5	1.3	10	4	50
YUSMXR03910	3.9	0.15	0.8	1.3	10	4	50
YUSMXR03915	3.9	0.15	0.8	1.3	15	4	50
YUSMXR04915	4.9	2	1	1.5	15	5	50
YUSMXR04922	4.9	2	1	1.5	22	5	50
YUSMXR05915	5.9	2	1.8	1.5	15	6	50
YUSMXR05922	5.9	2	1.8	1.5	22	6	50

可切削材料适用表 Applicable table for cutting materials

○ 非常合适 ○ 合适

碳素钢 carbon steel	合金钢 Alloy steel	预硬钢、淬硬钢 Prehardened steel, hardened steel				不锈钢 Stainless steel	铸铁 cast iron 球墨铸铁 Spheroidal graphite cast iron	铜合金 Copper alloy	铝合金 Aluminium alloy	铜合金 titanium alloy	耐热合金 Heat-resisting alloy
		~40HRC	~50HRC	~55HRC	~68HRC						
○	○	○	○	○	○		○	○	○	○	

Delivery 交货期 请咨询 Please ask Order 订货范例 Code No. YUSTR-S15056

可切削材料适用表 Applicable table for cutting materials

○ 非常合适 ○ 合适

碳素钢 carbon steel	合金钢 Alloy steel	预硬钢、淬硬钢 Prehardened steel, hardened steel				不锈钢 Stainless steel	铸铁 cast iron 球墨铸铁 Spheroidal graphite cast iron	铜合金 Copper alloy	铝合金 Aluminium alloy	铜合金 titanium alloy	耐热合金 Heat-resisting alloy
		~40HRC	~50HRC	~55HRC	~68HRC						
○	○	○	○	○	○		○	○	○	○	

Delivery 交货期 请咨询 Please ask Order 订货范例 Code No. YUSMXR02810

YUSMPR

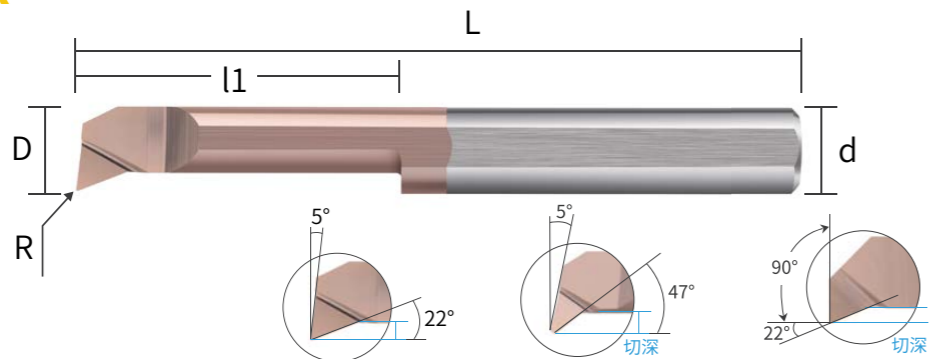

型号 Code No.	角度(°) °	刃径 D	R角 R	深度 Q	避空长度 l1	柄径 d	总长 L
YUSMPR-090053	22	0.8	0.05	0.12	3	4	50
YUSMPR-110053	22	1	0.05	0.15	3	4	50
YUSMPR-1300545	22	1.2	0.05	0.15	4.5	4	50
YUSMPR-150055	22	1.4	0.05	0.2	5	4	50
YUSMPR-170056	22	1.6	0.05	0.3	6	4	50
YUSMPR-190057	22	1.8	0.05	0.3	7	4	50
YUSMPR-200058	22	1.9	0.05	0.4	8	4	50
YUSMPR-20018	22	1.9	0.1	0.4	8	4	50
YUSMPR-2500510	22	2.4	0.05	0.5	10	4	50
YUSMPR-250110	22	2.4	0.1	0.5	10	4	50
YUSMPR-300058	22	2.9	0.05	0.6	8	4	50
YUSMPR-30018	22	2.9	0.1	0.6	8	4	50
YUSMPR-300158	22	2.9	0.15	0.6	8	4	50
YUSMPR-3000512	22	2.9	0.05	0.6	12	4	50
YUSMPR-300112	22	2.9	0.1	0.6	12	4	50
YUSMPR-3001512	22	2.9	0.15	0.6	12	4	50
YUSMPR-4000510	22	3.9	0.05	0.8	10	4	50
YUSMPR-400110	22	3.9	0.1	0.8	10	4	50
YUSMPR-4001510	22	3.9	0.15	0.8	10	4	50
YUSMPR-4000515	22	3.9	0.05	0.8	15	4	50
YUSMPR-400115	22	3.9	0.1	0.8	15	4	50
YUSMPR-4001515	22	3.9	0.15	0.8	15	4	50
YUSMPR-5000515	22	4.9	0.05	1	15	5	50
YUSMPR-500115	22	4.9	0.1	1	15	5	50
YUSMPR-500215	22	4.9	0.2	1	15	5	50
YUSMPR-5000522	22	4.9	0.05	1	22	5	50
YUSMPR-500122	22	4.9	0.1	1	22	5	50
YUSMPR-500222	22	4.9	0.2	1	22	5	50
YUSMPR-6000515	22	5.9	0.05	1.2	15	6	50
YUSMPR-600115	22	5.9	0.1	1.2	15	6	50
YUSMPR-600215	22	5.9	0.2	1.2	15	6	50
YUSMPR-6000522	22	5.9	0.05	1.2	22	6	50
YUSMPR-600122	22	5.9	0.1	1.2	22	6	50
YUSMPR-600222	22	5.9	0.2	1.2	22	6	50
YUSMPR-700122	22	6.9	0.1	1.5	22	8	60
YUSMPR-700222	22	6.9	0.2	1.5	22	8	60
YUSMPR-700130	22	6.9	0.1	1.5	30	8	60

YUSMPR-700230	22	6.9	0.2	1.5	30	8	60
YUSMPR-800122	22	7.9	0.1	1.8	22	8	60
YUSMPR-800222	22	7.9	0.2	1.8	22	8	60
YUSMPR-800130	22	7.9	0.1	1.8	30	8	60
YUSMPR-800230	22	7.9	0.2	1.8	30	8	60
YUSMQR-300059	47	2.9	0.05	0.7	9	4	50
YUSMQR-30019	47	2.9	0.1	0.7	9	4	50
YUSMQR-300159	47	2.9	0.15	0.7	9	4	50
YUSMQR-4000510	47	3.9	0.05	1	10	4	50
YUSMQR-400110	47	3.9	0.1	1	10	4	50
YUSMQR-400210	47	3.9	0.2	1	10	4	50
YUSMQR-400215	47	3.9	0.2	1	15	4	50
YUSMQR-5000515	47	4.9	0.05	1.2	15	5	50
YUSMQR-500115	47	4.9	0.1	1.2	15	5	50
YUSMQR-500215	47	4.9	0.2	1.2	15	5	50
YUSMQR-500220	47	4.9	0.2	1.2	20	5	50
YUSMQR-6000515	47	5.9	0.05	1.6	15	6	50
YUSMQR-600115	47	5.9	0.1	1.6	15	6	50
YUSMQR-600215	47	5.9	0.2	1.6	15	6	50
YUSMQR-600222	47	5.9	0.2	1.6	22	6	50
YUSMQR-800125	47	7.9	0.1	2.1	25	8	60
YUSMQR-800225	47	7.9	0.2	2.1	25	8	60
YUSMUR-300110	90	2.8	0.1	0.5	10	4	50
YUSMUR-300115	90	2.8	0.1	0.5	15	4	50
YUSMUR-400110	90	3.9	0.1	0.6	10	4	50
YUSMUR-400115	90	3.9	0.1	0.6	15	4	50
YUSMUR-5001515	90	4.9	0.15	0.7	15	5	50
YUSMUR-5001522	90	4.9	0.15	0.8	22	5	50
YUSMUR-600215	90	5.9	0.2	1	15	6	50
YUSMUR-600222	90	5.9	0.2	1	22	6	50
YUSMUR-800222	90	7.9	0.2	1.2	22	8	60

可切削材料适用表 Applicable table for cutting materials

非常合适 合适

碳素钢 carbon steel	合金钢 Alloy steel	预硬钢、淬硬钢 Prehardened steel, hardened steel				不锈钢 Stainless steel	铸铁 cast iron 球墨铸铁 Spheroidal graphite cast iron	铜合金 Copper alloy	铝合金 Aluminium alloy	铜合金 titanium alloy	耐热合金 Heat-resisting alloy
		~40HRC	~50HRC	~55HRC	~68HRC						
○	○	○	○	○	○	○	○	○	○	○	



Delivery  
交货期



请咨询  
Please ask



Order  
订货范例

Code No.  
YUSMPR-090053



YUSMI(R/L)

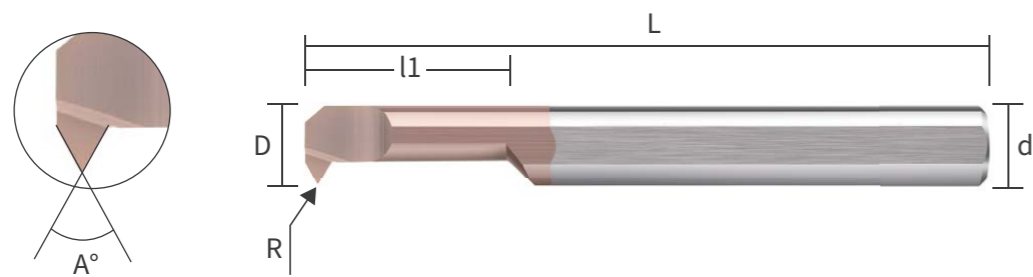

型号 Code No.	刃向 R/L	角度 A	刃径 D	R角 R	避空长度 l1	柄径 d	总长 L
YUSMIR-S3000510A55	R	55	2.9	0.05	10	4	50
YUSMIR-S4000512A55	R	55	3.9	0.05	12	4	50
YUSMIR-S400112A55	R	55	3.9	0.1	12	4	50
YUSMIR-S5000515A55	R	55	4.9	0.05	15	5	50
YUSMIR-S500115A55	R	55	4.9	0.1	15	5	50
YUSMIR-S6000522A55	R	55	5.9	0.05	22	6	50
YUSMIR-S600122A55	R	55	5.9	0.1	22	6	50
YUSMIR-S800122A55	R	55	7.9	0.1	22	8	60
YUSMIR-S10035A60	R	60	0.9	0	3.5	4	50
YUSMIR-S150034A60	R	60	1.4	0.03	4	4	50
YUSMIR-S200034A60	R	60	1.9	0.03	4	4	50
YUSMIR-S200036A60	R	60	1.9	0.03	6	4	50
YUSMIR-S250035A60	R	60	2.4	0.03	5	4	50
YUSMIR-S250037A60	R	60	2.4	0.03	7	4	50
YUSMIR-S300056A60	R	60	2.9	0.05	6	4	50
YUSMIR-S3000510A60	R	60	2.9	0.05	10	4	50
YUSMIR-S400058A60	R	60	3.9	0.05	8	4	50
YUSMIR-S4000512A60	R	60	3.9	0.05	12	4	50
YUSMIR-S500112A60	R	60	4.9	0.1	12	5	50
YUSMIR-S500115A60	R	60	4.9	0.1	15	5	50
YUSMIR-S600115A60	R	60	5.9	0.1	15	6	50
YUSMIR-S600122A60	R	60	5.9	0.1	22	6	50
YUSMIR-S800122A60	R	60	7.9	0.1	22	8	60
YUSMIL-S150034A60	L	60	1.4	0.03	4	4	50
YUSMIL-S200036A60	L	60	1.9	0.03	6	4	50
YUSMIL-S250037A60	L	60	2.4	0.03	7	4	50
YUSMIL-S3000510A60	L	60	2.9	0.05	10	4	50
YUSMIL-S4000512A60	L	60	3.9	0.05	12	4	50
YUSMIL-S500115A60	L	60	4.9	0.1	15	5	50
YUSMIL-S600122A60	L	60	5.9	0.1	22	6	50
YUSMIL-S800122A60	L	60	7.9	0.1	22	8	60

YUSO

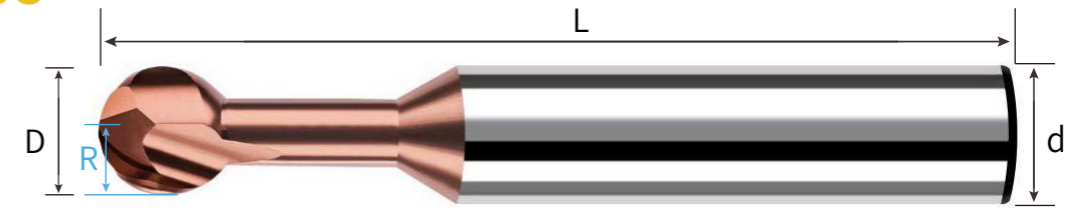

型号 Code No.	刃径 D	R角半径 R	柄径 d	总长 L	刃数 T
YUSO-2S020R1	2	1	4	50	2
YUSO-2S030R1.5	3	1.5	4	50	2
YUSO-2S040R2	4	2	4	50	2
YUSO-2S050R2.5	5	2.5	6	50	2
YUSO-2S060R3	6	3	6	50	2
YUSO-2S080R4	8	4	8	60	2
YUSO-2S100R5	10	5	10	60	2
YUSO-2S120R6	12	6	12	60	2

可切削材料适用表 Applicable table for cutting materials

非常合适 合适

碳素钢 carbon steel	合金钢 Alloy steel	预硬钢、淬硬钢 Prehardened steel, hardened steel				不锈钢 Stainless steel	铸铁 cast iron 球墨铸铁 Spheroidal graphite cast iron	铜合金 Copper alloy	铝合金 Aluminium alloy	铜合金 titanium alloy	耐热合金 Heat-resisting alloy
		~40HRC	~50HRC	~55HRC	~68HRC						
○	○	○	○	○	○	○	○	○	○	○	

Delivery 交货期 请咨询 Please ask Order 订货范例 Code No. YUSMIR-S3000510A55

可切削材料适用表 Applicable table for cutting materials

非常合适 合适

碳素钢 carbon steel	合金钢 Alloy steel	预硬钢、淬硬钢 Prehardened steel, hardened steel				不锈钢 Stainless steel	铸铁 cast iron 球墨铸铁 Spheroidal graphite cast iron	铜合金 Copper alloy	铝合金 Aluminium alloy	钛合金 titanium alloy	耐热合金 Heat-resisting alloy
		~40HRC	~50HRC	~55HRC	~68HRC						
○	○	○	○	○	○	○	○	○	○	○	

Delivery 交货期 请咨询 Please ask Order 订货范例 Code No. YUSO-2S020R1

YEAC

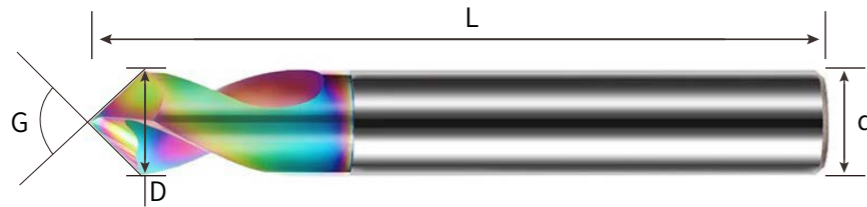

型号 Code No.	刃径 D	角度 G	柄径 d	总长 L	刃数 T
YEAC-2S005G90	0.5	90	4	50	2
YEAC-2S010G90	1	90	4	50	2
YEAC-2S015G90	1.5	90	4	50	2
YEAC-2S020G90	2	90	4	50	2
YEAC-2S025G90	2.5	90	4	50	2
YEAC-2S030G90	3	90	4	50	2
YEAC-2S040G90	4	90	4	50	2
YEAC-2S050G90	5	90	6	50	2
YEAC-2S060G90	6	90	6	50	2
YEAC-2L060G90	6	90	6	75	2
YEAC-2XL060G90	6	90	6	100	2
YEAC-2L040G90	4	90	4	75	2
YEAC-2XL040G90	4	90	4	100	2
YEAC-2S080G90	8	90	8	60	2
YEAC-2L080G90	8	90	8	75	2
YEAC-2XL080G90	8	90	8	100	2
YEAC-2S100G90	10	90	10	75	2
YEAC-2L100G90	10	90	10	100	2
YEAC-2S120G90	12	90	12	75	2
YEAC-2L120G90	12	90	12	100	2
YEAC-2S160G90	16	90	16	100	2
YEAC-2S200G90	20	90	20	100	2

YUSC

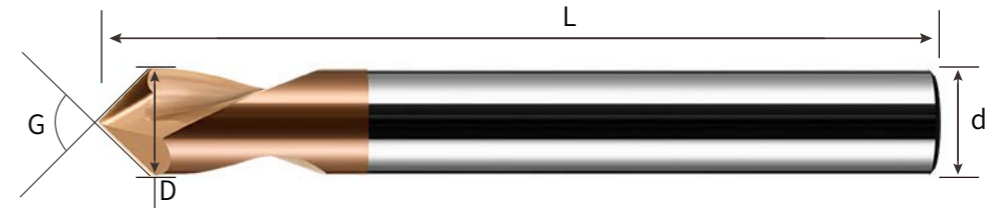

型号 Code No.	刃径 D	角度 G	柄径 d	总长 L	刃数 T
YUSC-2S005G90	0.5	90	4	50	2
YUSC-2S010G90	1	90	4	50	2
YUSC-2S015G90	1.5	90	4	50	2
YUSC-2S020G90	2	90	4	50	2
YUSC-2S025G90	2.5	90	4	50	2
YUSC-2S030G90	3	90	4	50	2
YUSC-2S040G90	4	90	4	50	2
YUSC-2S050G90	5	90	6	50	2
YUSC-2S060G90	6	90	6	50	2
YUSC-2L060G90	6	90	6	75	2
YUSC-2XL060G90	6	90	6	100	2
YUSC-2L040G90	4	90	4	75	2
YUSC-2XL040G90	4	90	4	100	2
YUSC-2S080G90	8	90	8	60	2
YUSC-2L080G90	8	90	8	75	2
YUSC-2XL080G90	8	90	8	100	2
YUSC-2S100G90	10	90	10	75	2
YUSC-2L100G90	10	90	10	100	2
YUSC-2S120G90	12	90	12	75	2
YUSC-2L120G90	12	90	12	100	2
YUSC-2S160G90	16	90	16	100	2
YUSC-2S200G90	20	90	20	100	2

可切削材料适用表 Applicable table for cutting materials

非常合适 合适

碳素钢 carbon steel	合金钢 Alloy steel	预硬钢、淬硬钢 Prehardened steel, hardened steel				不锈钢 Stainless steel	铸铁 cast iron 球墨铸铁 Spheroidal graphite cast iron	铜合金 Copper alloy	铝合金 Aluminium alloy	钛合金 titanium alloy	耐热合金 Heat-resisting alloy
		~40HRC	~50HRC	~55HRC	~68HRC						

Delivery 交货期 请咨询 Please ask Order 订货范例 Code No. YEAC-2S005G90

可切削材料适用表 Applicable table for cutting materials

非常合适 合适

碳素钢 carbon steel	合金钢 Alloy steel	预硬钢、淬硬钢 Prehardened steel, hardened steel				不锈钢 Stainless steel	铸铁 cast iron 球墨铸铁 Spheroidal graphite cast iron	铜合金 Copper alloy	铝合金 Aluminium alloy	钛合金 titanium alloy	耐热合金 Heat-resisting alloy
		~40HRC	~50HRC	~55HRC	~68HRC						

Delivery 交货期 请咨询 Please ask Order 订货范例 Code No. YUSC-2S005G90

YUSCV

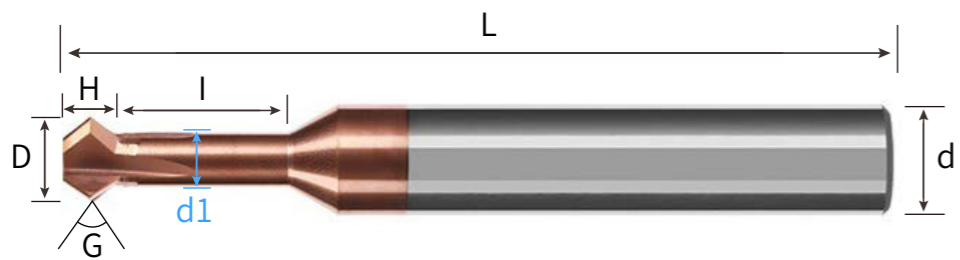

YEACV

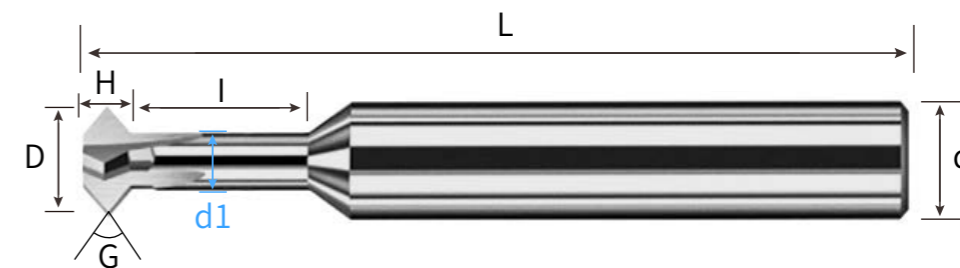

型号	刃径	角度	刃宽	侧径	侧径长度	柄径	总长
Code No.	D	G	H	d1	l	d	L
YUSCV-4S020G60	2	60	0.64	0.9	3	4	50
YUSCV-4S030G60	3	60	0.92	1.4	4	4	50
YUSCA-4S040G60	4	60	1.24	1.9	8	4	50
YUSCV-4S050G60	5	60	1.56	2.3	10	6	50
YUSCV-4S060G60	6	60	1.9	2.8	10	6	50
YUSCV-4S080G60	8	60	2.54	3.6	12	8	60
YUSCV-4S100G60	10	60	3.18	4.5	15	10	60
YUSCV-4S120G60	12	60	3.81	5.4	18	12	60
YUSCV-4S020G90	2	90	1.1	0.9	3	4	50
YUSCV-4S030G90	3	90	1.6	1.4	4	4	50
YUSCA-4S040G90	4	90	2.15	1.9	8	4	50
YUSCV-4S050G90	5	90	2.7	2.3	10	6	50
YUSCV-4S060G90	6	90	3.3	2.8	10	6	50
YUSCV-4S080G90	8	90	4.4	3.6	12	8	60
YUSCV-4S100G90	10	90	5.5	4.5	15	10	60
YUSCV-4S120G90	12	90	6.6	5.4	18	12	60
YUSCV-4S020G120	2	120	1.9	0.9	3	4	50
YUSCV-4S030G120	3	120	2.77	1.4	4	4	50
YUSCA-4S040G120	4	120	3.72	1.9	8	4	50
YUSCV-4S050G120	5	120	4.67	2.3	10	6	50
YUSCV-4S060G120	6	120	5.71	2.8	10	6	50
YUSCV-4S080G120	8	120	7.62	3.6	12	8	60
YUSCV-4S100G120	10	120	9.53	4.5	15	10	60
YUSCV-4S120G120	12	120	11.43	5.4	18	12	60

型号	刃径	角度	刃宽	侧径	侧径长度	柄径	总长
Code No.	D	G	H	d1	l	d	L
YEACV-4S020G60	2	60	0.64	0.9	3	4	50
YEACV-4S030G60	3	60	0.92	1.4	4	4	50
YEACV-4S040G60	4	60	1.24	1.9	8	4	50
YEACV-4S050G60	5	60	1.56	2.3	10	6	50
YEACV-4S060G60	6	60	1.9	2.8	10	6	50
YEACV-4S080G60	8	60	2.54	3.6	12	8	60
YEACV-4S100G60	10	60	3.18	4.5	15	10	60
YEACV-4S120G60	12	60	3.81	5.4	18	12	60
YEACV-4S020G90	2	90	1.1	0.9	3	4	50
YEACV-4S030G90	3	90	1.6	1.4	4	4	50
YEACV-4S040G90	4	90	2.15	1.9	8	4	50
YEACV-4S050G90	5	90	2.7	2.3	10	6	50
YEACV-4S060G90	6	90	3.3	2.8	10	6	50
YEACV-4S080G90	8	90	4.4	3.6	12	8	60
YEACV-4S100G90	10	90	5.5	4.5	15	10	60
YEACV-4S120G90	12	90	6.6	5.4	18	12	60
YEACV-4S020G120	2	120	1.9	0.9	3	4	50
YEACV-4S030G120	3	120	2.77	1.4	4	4	50
YEACV-4S040G120	4	120	3.72	1.9	8	4	50
YEACV-4S050G120	5	120	4.67	2.3	10	6	50
YEACV-4S060G120	6	120	5.71	2.8	10	6	50
YEACV-4S080G120	8	120	7.62	3.6	12	8	60
YEACV-4S100G120	10	120	9.53	4.5	15	10	60
YEACV-4S120G120	12	120	11.43	5.4	18	12	60

可切削材料适用表 Applicable table for cutting materials

非常合适 合适

碳素钢 carbon steel	合金钢 Alloy steel	预硬钢、淬硬钢 Prehardened steel, hardened steel				不锈钢 Stainless steel	铸铁 cast iron 球墨铸铁 Spheroidal graphite cast iron	铜合金 Copper alloy	铝合金 Aluminium alloy	钛合金 titanium alloy	耐热合金 Heat-resisting alloy
		~40HRC	~50HRC	~55HRC	~68HRC						
○	○	○	○	○	○	○	○	○	○	○	

Delivery 交货期 请咨询 Please ask Order 订货范例 Code No. YUSC-2S005G90

可切削材料适用表 Applicable table for cutting materials

非常合适 合适

碳素钢 carbon steel	合金钢 Alloy steel	预硬钢、淬硬钢 Prehardened steel, hardened steel				不锈钢 Stainless steel	铸铁 cast iron 球墨铸铁 Spheroidal graphite cast iron	铜合金 Copper alloy	铝合金 Aluminium alloy	钛合金 titanium alloy	耐热合金 Heat-resisting alloy
		~40HRC	~50HRC	~55HRC	~68HRC						
							○	○			

Delivery 交货期 请咨询 Please ask Order 订货范例 Code No. YEACV-4S020G60

YUSC

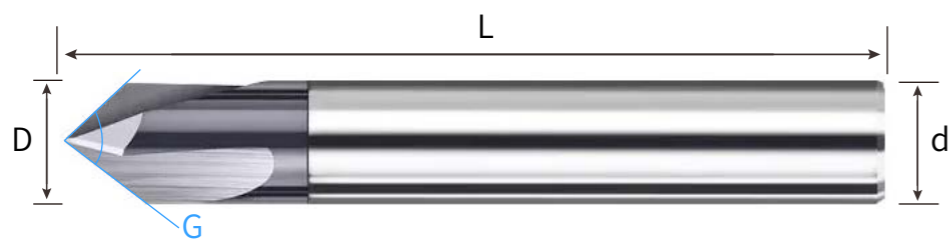

型号 Code No.	刃径 D	角度 G	柄径 d	总长 L	刃数 F
YUSC-3S010G60	1	60	4	50	3
YUSC-3S020G60	2	60	4	50	3
YUSC-3S030G60	3	60	4	50	3
YUSC-3S040G60	4	60	4	50	3
YUSC-3S050G60	5	60	5	50	3
YUSC-3S060G60	6	60	6	50	3
YUSC-3S080G60	8	60	8	60	3
YUSC-3S100G60	10	60	10	60	3
YUSC-3S120G60	12	60	12	60	3
YUSC-3S010G90	1	90	4	50	3
YUSC-3S020G90	2	90	4	50	3
YUSC-3S030G90	3	90	4	50	3
YUSC-3S040G90	4	90	4	50	3
YUSC-3S050G90	5	90	5	50	3
YUSC-3S060G90	6	90	6	50	3
YUSC-3S080G90	8	90	8	60	3
YUSC-3S100G90	10	90	10	60	3
YUSC-3S120G90	12	90	12	60	3
YUSC-3S010G120	1	120	4	50	3
YUSC-3S020G120	2	120	4	50	3
YUSC-3S030G120	3	120	4	50	3
YUSC-3S040G120	4	120	4	50	3
YUSC-3S050G120	5	120	5	50	3
YUSC-3S060G120	6	120	6	50	3
YUSC-3S080G120	8	120	8	60	3
YUSC-3S100G120	10	120	10	60	3
YUSC-3S120G120	12	120	12	60	3

YUSNR

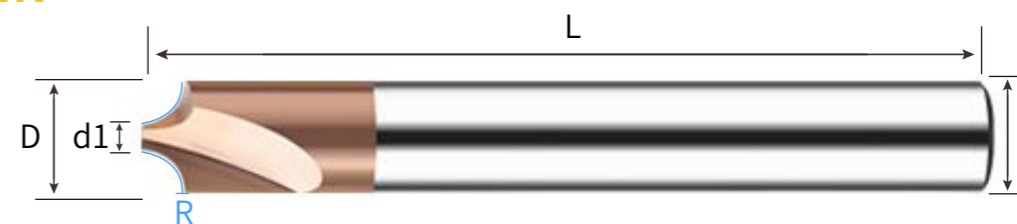

型号 Code No.	内R角 R	刃径 D	底径 d1	柄径 d	总长 L	刃数 F
YUSNR-4S038R02	0.2	4	3.8	4	50	4
YUSNR-4S034R03	0.3	4	3.4	4	50	4
YUSNR-4S032R04	0.4	4	3.2	4	50	4
YUSNR-4S030R05	0.5	4	3	4	50	4
YUSNR-4S028R06	0.6	4	2.8	4	50	4
YUSNR-4S026R07	0.7	4	2.6	4	50	4
YUSNR-4S025R075	0.75	4	2.5	4	50	4
YUSNR-4S024R08	0.8	4	2.4	4	50	4
YUSNR-4S020R10	1	4	2	4	50	4
YUSNR-4S040R10	1	6	4	6	50	4
YUSNR-4S030R15	1.5	6	3	6	50	4
YUSNR-4S020R20	2	6	2	6	50	4
YUSNR-4S040R20	2	8	4	8	60	4
YUSNR-4S030R25	2.5	8	3	8	60	4
YUSNR-4S020R30	3	8	2	8	60	4
YUSNR-4S040R30	3	10	4	10	60	4
YUSNR-4S030R35	3.5	10	3	10	60	4
YUSNR-4S020R40	4	10	2	10	60	4
YUSNR-4S030R45	4.5	12	3	12	60	4
YUSNR-4S020R50	5	12	2	12	60	4
YUSNR-4S030R55	5.5	14	3	14	70	4
YUSNR-4S040R60	6	16	4	16	70	4
YUSNR-4S040R80	8	20	4	20	70	4

可切削材料适用表 Applicable table for cutting materials

非常合适 合适

碳素钢 carbon steel	合金钢 Alloy steel	预硬钢、淬硬钢 Prehardened steel, hardened steel				不锈钢 Stainless steel	铸铁 cast iron 球墨铸铁 Spheroidal graphite cast iron	铜合金 Copper alloy	铝合金 Aluminium alloy	钛合金 titanium alloy	耐热合金 Heat-resisting alloy
		~40HRC	~50HRC	~55HRC	~68HRC						
○	○	○	○	○	○		○		○	○	

Delivery 交货期 请咨询 Please ask Order 订货范例 Code No. YUSC-3S010G60

可切削材料适用表 Applicable table for cutting materials

非常合适 合适

碳素钢 carbon steel	合金钢 Alloy steel	预硬钢、淬硬钢 Prehardened steel, hardened steel				不锈钢 Stainless steel	铸铁 cast iron 球墨铸铁 Spheroidal graphite cast iron	铜合金 Copper alloy	铝合金 Aluminium alloy	钛合金 titanium alloy	耐热合金 Heat-resisting alloy
		~40HRC	~50HRC	~55HRC	~68HRC						
○	○	○	○	○	○		○		○	○	

Delivery 交货期 请咨询 Please ask Order 订货范例 Code No. YUSNR-4S038R02

YEANR

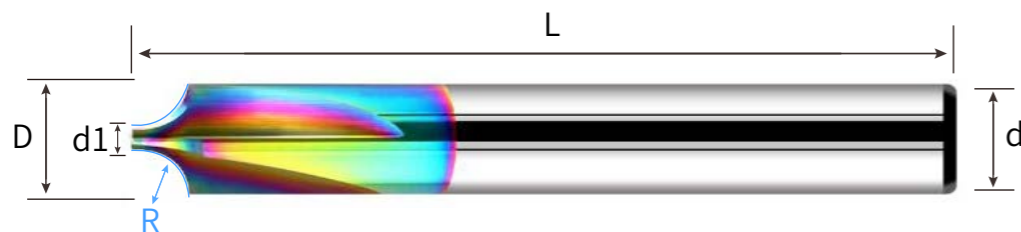

型号 Code No.	内R角 R	刃径 D	底径 d1	柄径 d	总长 L	刃数 F
YEANR-4S038R02	0.2	4	3.8	4	50	4
YEANR-4S034R03	0.3	4	3.4	4	50	4
YEANR-4S032R04	0.4	4	3.2	4	50	4
YEANR-4S030R05	0.5	4	3	4	50	4
YEANR-4S028R06	0.6	4	2.8	4	50	4
YEANR-4S026R07	0.7	4	2.6	4	50	4
YEANR-4S025R075	0.75	4	2.5	4	50	4
YEANR-4S024R08	0.8	4	2.4	4	50	4
YEANR-4S020R10	1	4	2	4	50	4
YEANR-4S040R10	1	6	4	6	50	4
YEANR-4S030R15	1.5	6	3	6	50	4
YEANR-4S020R20	2	6	2	6	50	4
YEANR-4S040R20	2	8	4	8	60	4
YEANR-4S030R25	2.5	8	3	8	60	4
YEANR-4S020R30	3	8	2	8	60	4
YEANR-4S040R30	3	10	4	10	60	4
YEANR-4S030R35	3.5	10	3	10	60	4
YEANR-4S020R40	4	10	2	10	60	4
YEANR-4S030R45	4.5	12	3	12	60	4
YEANR-4S020R50	5	12	2	12	60	4
YEANR-4S030R55	5.5	14	3	14	70	4
YEANR-4S040R60	6	16	4	16	70	4
YEANR-4S040R80	8	20	4	20	70	4

YUSCV

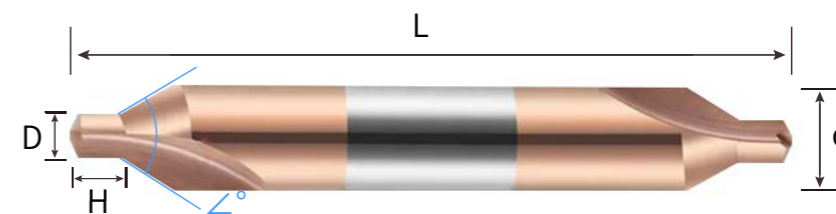

型号 Code No.	刃径 D	刃长 H	柄径 d	总长 L
YUSCV-S0408	0.4	0.8	4	50
YUSCV-S0510	0.5	1	4	50
YUSCV-S0612	0.6	1.2	4	50
YUSCV-S0714	0.7	1.4	4	50
YUSCV-S0815	0.8	1.5	4	50
YUSCV-S0915	0.9	1.5	4	50
YUSCV-S1015	1	1.5	4	50
YUSCV-S1118	1.1	1.8	4	50
YUSCV-S1218	1.2	1.8	4	50
YUSCV-S1318	1.3	1.8	4	50
YUSCV-S1420	1.4	2	4	50
YUSCV-S1520	1.5	2	4	50
YUSCV-S1620	1.6	2	4	50
YUSCV-S1722	1.7	2.2	4	50
YUSCV-S1822	1.8	2.2	4	50
YUSCV-S1922	1.9	2.2	4	50
YUSCV-S2025	2	2.5	4	50
YUSCV-S202506	2	2.5	6	50
YUSCV-S2530	2.5	3	6	50
YUSCV-S3035	3	3.5	6	60
YUSCV-S303508	3	3.5	8	60
YUSCV-S4050	4	5	8	60
YUSCV-S405010	4	5	10	60
YUSCV-S5065	5	6.5	10	60
YUSCV-S6075	6	7.5	10	60
YUSCV-L1015	1	1.5	4	100
YUSCV-L1520	1.5	2	4	100
YUSCV-L2025	2	2.5	4	100
YUSCV-L202506	2	2.5	6	100
YUSCV-L3035	3	3.5	6	100
YUSCV-L303508	3	3.5	8	100
YUSCV-L4050	4	5	8	100
YUSCV-L405010	4	5	10	100
YUSCV-L5065	5	6.5	10	100

可切削材料适用表 Applicable table for cutting materials

非常合适 合适

碳素钢 carbon steel	合金钢 Alloy steel	预硬钢、淬硬钢 Prehardened steel, hardened steel				不锈钢 Stainless steel	铸铁 cast iron 球墨铸铁 Spheroidal graphite cast iron	铜合金 Copper alloy	铝合金 Aluminium alloy	钛合金 titanium alloy	耐热合金 Heat-resisting alloy	
		~40HRC	~50HRC	~55HRC	~68HRC							
											○	○

Delivery 交货期 请咨询 Please ask Order 订货范例 Code No. YEANR-4S038R02

可切削材料适用表 Applicable table for cutting materials

非常合适 合适

碳素钢 carbon steel	合金钢 Alloy steel	预硬钢、淬硬钢 Prehardened steel, hardened steel				不锈钢 Stainless steel	铸铁 cast iron 球墨铸铁 Spheroidal graphite cast iron	铜合金 Copper alloy	铝合金 Aluminium alloy	钛合金 titanium alloy	耐热合金 Heat-resisting alloy
		~40HRC	~50HRC	~55HRC	~68HRC						
○	○	○	○	○	○	○	○	○	○	○	

Delivery 交货期 请咨询 Please ask Order 订货范例 Code No. YUSCV-S0408

YEAH

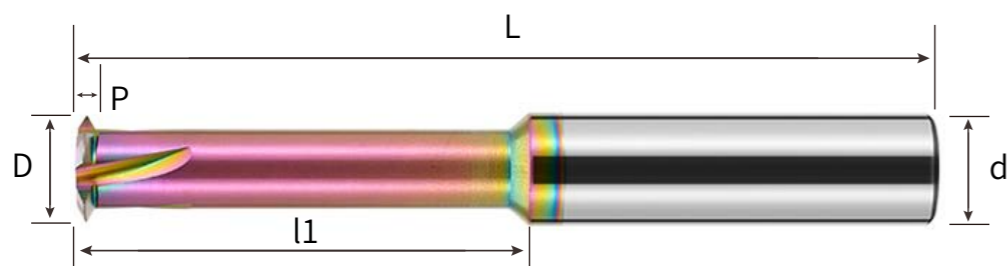

型号 Code No.	牙距 P	刃径 D	避空长度 l1	柄径 d	总长 L
YEAH-S025072	P0.25	0.72	2.5	4	50
YEAH-S025090	P0.25	0.9	3.2	4	50
YEAH-S030105	P0.25-0.35	1.05	3.5	4	50
YEAH-S035120	P0.25-0.35	1.2	4	4	50
YEAH-S0405155	P0.4-0.5	1.55	6	4	50
YEAH-S04506196	P0.45-0.6	1.96	6.5	4	50
YEAH-S0507235	P0.5-0.7	2.35	8	4	50
YEAH-S0510315	P0.5-1.0	3.15	10	4	50
YEAH-S0510390	P0.5-1.0	3.9	12	4	50
YEAH-S0515480	P0.5-1.5	4.8	15	6	50
YEAH-S0515600	P0.5-1.5	6	20	6	50
YEAH-S0820770	P0.8-2.0	7.7	25	8	60
YEAH-S1025960	P1.0-2.5	9.6	30	10	75
YEAH-S1030100	P1.0-3.0	10	36	10	75
YEAH-S12535120	P1.25-3.5	12	38	12	75

YEAH

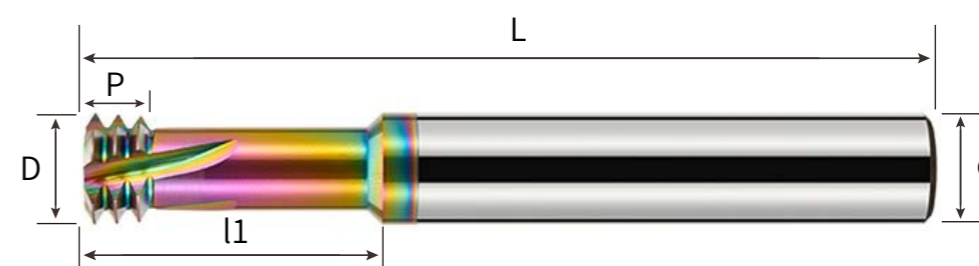

型号 Code No.	牙距 P	刃径 D	刃长 H	柄径 d	总长 L
YEAH-S3T025073	M1.0*0.25	0.73	3	4	50
YEAH-S3T025092	M1.2*0.25	0.92	3.6	4	50
YEAH-S3T030105	M1.4*0.3	1.05	4.2	4	50
YEAH-S3T035120	M1.6*0.35	1.2	4.8	4	50
YEAH-S3T040155	M2.0*0.4	1.55	6	4	50
YEAH-S3T045200	M2.5*0.45	2	7.5	4	50
YEAH-S3T050240	M3.0*0.5	2.4	9	4	50
YEAH-S3T070315	M4.0*0.7	3.15	12	4	50
YEAH-S3T080400	M5.0*0.8	4	15	4	50
YEAH-S3T100480	M6.0*1.0	4.8	12	6	50
YEAH-SL3T100480	M6.0*1.0	4.8	18	6	50
YEAH-S3T125600	M8*1.25	6	16	6	50
YEAH-SL3T125600	M8*1.25	6	24	6	50
YEAH-S3T150800	M10*1.5	8	20	8	60
YEAH-SL3T150800	M10*1.5	8	30	8	60
YEAH-SL3T175100	M12*1.75	10	36	10	75
YEAH-S3T200100	M14*2.0	10	28	10	75

可切削材料适用表 Applicable table for cutting materials

○ 非常合适 ○ 合适

碳素钢 carbon steel	合金钢 Alloy steel	预硬钢、淬硬钢 Prehardened steel, hardened steel				不锈钢 Stainless steel	铸铁 cast iron 球墨铸铁 Spheroidal graphite cast iron	铜合金 Copper alloy	铝合金 Aluminium alloy	钛合金 titanium alloy	耐热合金 Heat-resisting alloy
		~40HRC	~50HRC	~55HRC	~68HRC						
											○

Delivery 交货期  
 请咨询 Please ask  
 Order 订货范例  
 Code No. **YEAH-S025072**

可切削材料适用表 Applicable table for cutting materials

○ 非常合适 ○ 合适

碳素钢 carbon steel	合金钢 Alloy steel	预硬钢、淬硬钢 Prehardened steel, hardened steel				不锈钢 Stainless steel	铸铁 cast iron 球墨铸铁 Spheroidal graphite cast iron	铜合金 Copper alloy	铝合金 Aluminium alloy	钛合金 titanium alloy	耐热合金 Heat-resisting alloy
		~40HRC	~50HRC	~55HRC	~68HRC						
											○

Delivery 交货期  
 请咨询 Please ask  
 Order 订货范例  
 Code No. **YEAH-S3T025073**

### YUSNPT

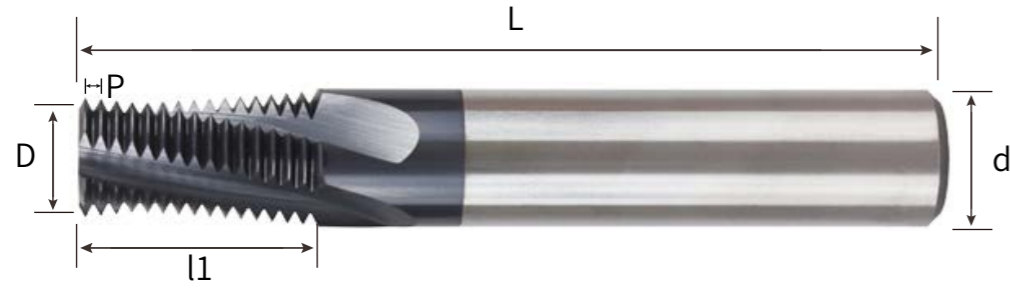

型号	牙距	刃径	刃长	柄径	总长
Code No.	P	D	l1	d	L
YUSNPT-T27054	1/16-27	5.4	9.4	6	60
YUSNPT-T27074	1/8-27	7.4	9.4	8	60
YUSNPT-T18071	1/4-18	7.1	14.1	8	60
YUSNPT-T18091	1/4-18	9.1	14.1	10	75
YUSNPT-T18111	3/8-18	11.1	14.1	12	75
YUSNPT-T14108	1/2-14	10.8	18.1	12	75
YUSNPT-T14148	3/4-14	14.8	18.1	16	100
YUSNPT-T115146	1"-11.5	14.6	22	16	100
YUSNPT-T1151768	1"-11.5	17.68	42	20	100

### YUSNPTF

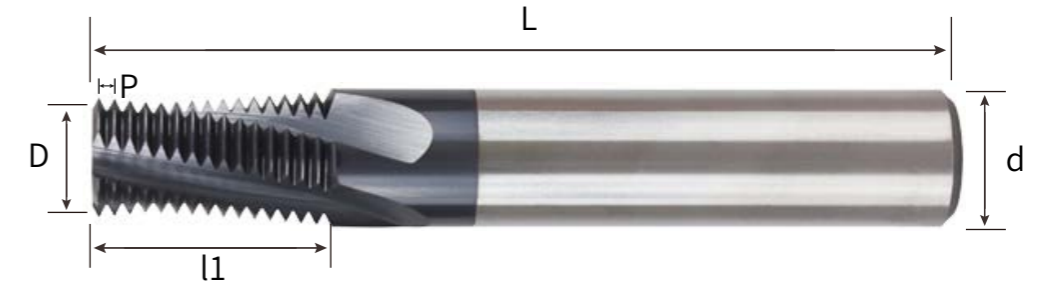

型号	牙距	刃径	刃长	柄径	总长
Code No.	P	D	l1	d	L
YUSNPTF-T27054	1/16-27	5.4	9.4	6	60
YUSNPTF-T27074	1/8-27	7.4	9.4	8	60
YUSNPTF-T18071	1/4-18	7.1	14.1	8	60
YUSNPTF-T18091	1/4-18	9.1	14.1	10	75
YUSNPTF-T18111	3/8-18	11.1	14.1	12	75
YUSNPTF-T14108	1/2-14	10.8	18.1	12	75
YUSNPTF-T14148	3/4-14	14.8	18.1	16	100
YUSNPTF-T115146	1"-11.5	14.6	22	16	100
YUSNPTF-T1151768	1"-11.5	17.68	42	20	100

#### 可切削材料适用表 Applicable table for cutting materials

○ 非常合适 ○ 合适

碳素钢 carbon steel	合金钢 Alloy steel	预硬钢、淬硬钢 Prehardened steel, hardened steel				不锈钢 Stainless steel	铸铁 cast iron 球墨铸铁 Spheroidal graphite cast iron	铜合金 Copper alloy	铝合金 Aluminium alloy	钛合金 titanium alloy	耐热合金 Heat-resisting alloy
		~40HRC	~50HRC	~55HRC	~68HRC						
○	○	○	○	○	○	○	○	○	○	○	

Delivery 交货期 请咨询 Please ask Order 订货范例 Code No. YUSNPT-T27054

#### 可切削材料适用表 Applicable table for cutting materials

○ 非常合适 ○ 合适

碳素钢 carbon steel	合金钢 Alloy steel	预硬钢、淬硬钢 Prehardened steel, hardened steel				不锈钢 Stainless steel	铸铁 cast iron 球墨铸铁 Spheroidal graphite cast iron	铜合金 Copper alloy	铝合金 Aluminium alloy	钛合金 titanium alloy	耐热合金 Heat-resisting alloy
		~40HRC	~50HRC	~55HRC	~68HRC						
○	○	○	○	○	○	○	○	○	○	○	

Delivery 交货期 请咨询 Please ask Order 订货范例 Code No. YUSNPTF-T27054

YUSTR

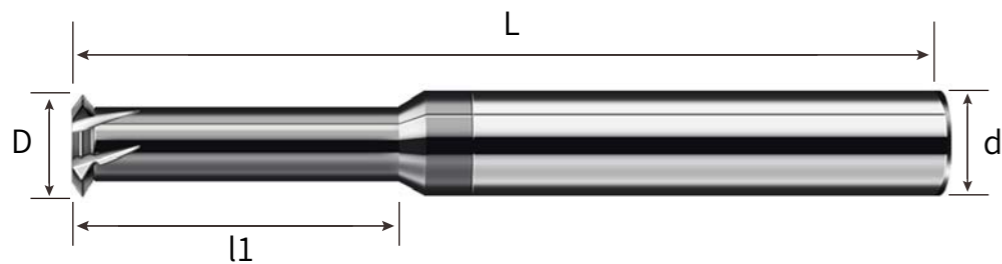

型号 Code No.	牙距 P	刃径 D	避空长度 l1	柄径 d	总长 L
YUSTR-S0710055	TR7*1.0	5.5	20	6	50
YUSTR-S0815060	TR8*1.5	6	20	6	50
YUSTR-S0915060	TR9*1.5	6	20	6	50
YUSTR-S0920064	TR9*2	6.4	20	8	60
YUSTR-S1020064	TR10*2	6.4	20	8	60
YUSTR-S1120064	TR11*2	6.4	20	8	60
YUSTR-S1220094	TR12*2	9.4	35	10	75
YUSTR-S1420094	TR14*2	9.4	35	10	75
YUSTR-S1620094	TR16*2	9.4	35	10	75
YUSTR-S1820094	TR18*2	9.4	35	10	75
YUSTR-S2020094	TR20*2	9.4	35	10	75
YUSTR-S1130074	TR11*3	7.4	25	8	60
YUSTR-S1230074	TR12*3	7.4	25	8	60
YUSTR-S1430074	TR14*3	7.4	25	8	60
YUSTR-S1430100	TR14*3	10	35	10	75
YUSTR-S2230100	TR22*3	10	35	10	75
YUSTR-S2430100	TR24*3	10	35	10	75
YUSTR-S2630100	TR26*3	10	35	10	75
YUSTR-S2830100	TR28*3	10	35	10	75
YUSTR-S3030100	TR30*3	10	35	10	75
YUSTR-S1640110	TR16*4	11	38	12	75
YUSTR-S1840110	TR18*4	11	38	12	75
YUSTR-S2040110	TR20*4	11	38	12	75
YUSTR-S2250140	TR22*5	14	50	14	100
YUSTR-S2450140	TR24*5	14	50	14	100
YUSTR-S2650140	TR26*5	14	50	14	100
YUSTR-S2850140	TR28*5	14	50	14	100
YUSTR-S3060160	TR30*6	16	50	16	100
YUSTR-S3260160	TR32*6	16	50	16	100
YUSTR-S3460160	TR34*6	16	50	16	100
YUSTR-S3660160	TR36*6	16	50	16	100
YUSTR-S3860160	TR38*6	16	50	16	100
YUSTR-S4060160	TR40*6	16	50	16	100
YUSTR-S4260160	TR42*6	16	50	16	100

YUSPG

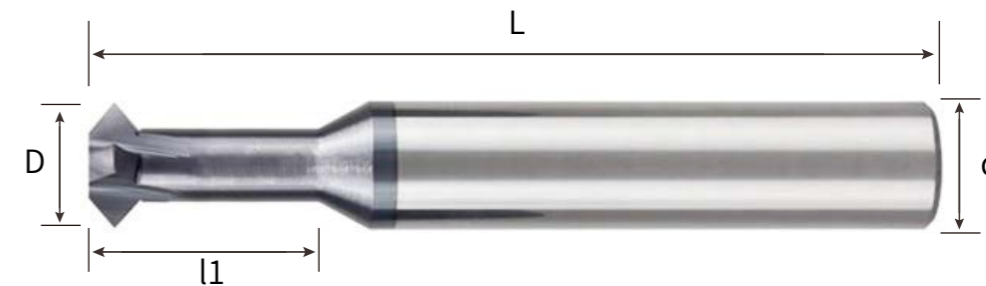

型号 Code No.	牙距 P	刃径 D	避空长度 l1	柄径 d	总长 L
YUSPG-P7080	PG7	8	15	8	60
YUSPG-P9080	PG9	8	15	8	60
YUSPG-P11080	PG11	8	15	8	60
YUSPG-P135080	PG13.5	8	15	8	60
YUSPG-P16080	PG16	8	15	8	60
YUSPG-P9100	PG9	10	20	10	75
YUSPG-P11100	PG11	10	20	10	75
YUSPG-P135100	PG13.5	10	20	10	75
YUSPG-P16100	PG16	10	20	10	75
YUSPG-P21120	PG21	12	20	12	75
YUSPG-P29120	PG29	12	20	12	75
YUSPG-P36120	PG36	12	20	12	75
YUSPG-P42120	PG42	12	20	12	75
YUSPG-P48120	PG48	12	20	12	75

可切削材料适用表 Applicable table for cutting materials

○ 非常合适 ○ 合适

碳素钢 carbon steel	合金钢 Alloy steel	预硬钢、淬硬钢 Prehardened steel, hardened steel				不锈钢 Stainless steel	铸铁 cast iron 球墨铸铁 Spheroidal graphite cast iron	铜合金 Copper alloy	铝合金 Aluminium alloy	钛合金 titanium alloy	耐热合金 Heat-resisting alloy
		~40HRC	~50HRC	~55HRC	~68HRC						
○	○	○	○	○	○	○	○	○	○	○	

Delivery 交货期 请咨询 Please ask Order 订货范例 Code No. YUSTR-S0710055

可切削材料适用表 Applicable table for cutting materials

○ 非常合适 ○ 合适

碳素钢 carbon steel	合金钢 Alloy steel	预硬钢、淬硬钢 Prehardened steel, hardened steel				不锈钢 Stainless steel	铸铁 cast iron 球墨铸铁 Spheroidal graphite cast iron	铜合金 Copper alloy	铝合金 Aluminium alloy	钛合金 titanium alloy	耐热合金 Heat-resisting alloy
		~40HRC	~50HRC	~55HRC	~68HRC						
○	○	○	○	○	○	○	○	○	○	○	

Delivery 交货期 请咨询 Please ask Order 订货范例 Code No. YUSPG-P7080



### YUSACME

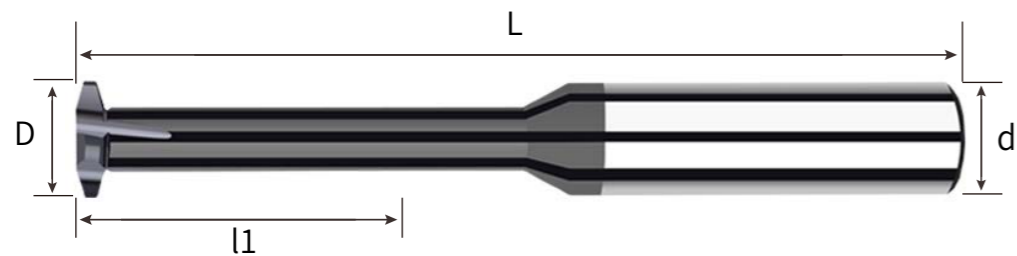

型号 Code No.	牙距 P	刃径 D	避空长度 l1	柄径 d	总长 L
YUSACME-1/4	1/4-16	4.7	15	6	50
YUSACME-5/16	5/16-14	6	20	6	50
YUSACME-3/8	3/8-12	7.2	25	8	60
YUSACME-7/16	7/16-12	7.2	25	8	60
YUSACME-1/2	1/2-10	10	35	10	75
YUSACME-5/8	5/8-8	12	35	12	75
YUSACME-3/4	3/4-6	12	35	12	75
YUSACME-7/8	7/8-6	12	35	12	75

### YUSH

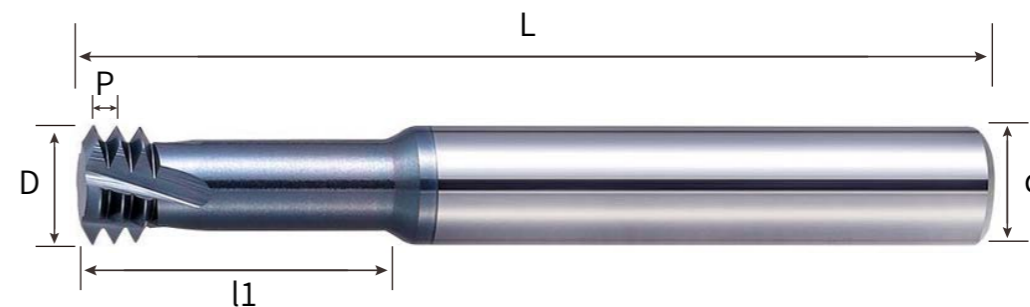

型号 Code No.	牙距 P	刃径 D	避空长度 l1	柄径 d	总长 L	冷却
YUSH-S05024	M3.0*0.5	2.4	7	6	50	外冷
YUSH-S0732	M4.0*0.7	3.2	9	6	50	外冷
YUSH-S0839	M5.0*0.8	3.9	12	6	50	外冷
YUSH-S1047	M6.0*1.0	4.7	14	6	50	外冷
YUSH-S125062	M8*1.25	6.2	18	8	60	内冷
YUSH-S15075	M10*1.5	7.5	23	8	60	内冷
YUSH-S175090	M12*1.75	9	26	10	75	内冷

#### 可切削材料适用表 Applicable table for cutting materials

○ 非常合适 ○ 合适

碳素钢 carbon steel	合金钢 Alloy steel	预硬钢、淬硬钢 Prehardened steel, hardened steel				不锈钢 Stainless steel	铸铁 cast iron 球墨铸铁 Spheroidal graphite cast iron	铜合金 Copper alloy	铝合金 Aluminium alloy	钛合金 titanium alloy	耐热合金 Heat-resisting alloy
		~40HRC	~50HRC	~55HRC	~68HRC						
○	○	○	○	○	○	○	○	○	○	○	

Delivery 交货期 | 请咨询 Please ask | Order 订货范例 Code No. YUSACME-1/4

#### 可切削材料适用表 Applicable table for cutting materials

○ 非常合适 ○ 合适

碳素钢 carbon steel	合金钢 Alloy steel	预硬钢、淬硬钢 Prehardened steel, hardened steel				不锈钢 Stainless steel	铸铁 cast iron 球墨铸铁 Spheroidal graphite cast iron	铜合金 Copper alloy	铝合金 Aluminium alloy	钛合金 titanium alloy	耐热合金 Heat-resisting alloy
		~40HRC	~50HRC	~55HRC	~68HRC						
○	○	○	○	○	○	○	○	○	○	○	

Delivery 交货期 | 请咨询 Please ask | Order 订货范例 Code No. YUSH-S05024

YUSH

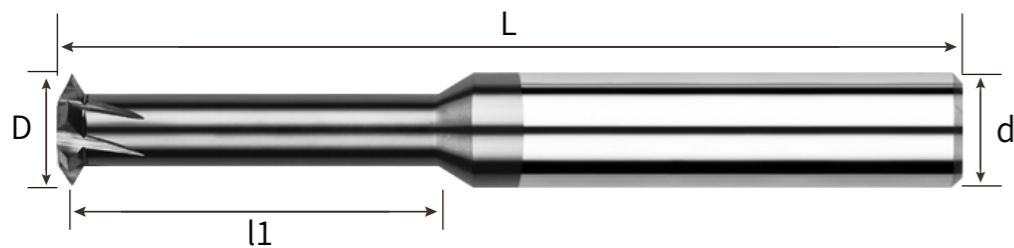

型号 Code No.	牙距 P	刃径 D	避空长度 l1	柄径 d	总长 L
YUSH-SL0508039	P0.5-P0.8	3.9	16	4	50
YUSH-SL05100485	P0.5-P1.0	4.85	20	6	60
YUSH-SL05125059	P0.5-P1.25	5.9	25	6	60
YUSH-SL0510098	P0.5-P1.0	9.8	35	10	75
YUSH-SL1015079	P1.0-P1.5	7.9	32	8	75
YUSH-SL10175099	P1.0-P1.75	9.9	38	10	75
YUSH-SL1020119	P1.0-P2.0	11.9	40	12	75
YUSH-SL2030140	P2.0-P3.0	14	48	14	100
YUSH-SL2035160	P2.0-P3.5	16	50	16	100

YUSH

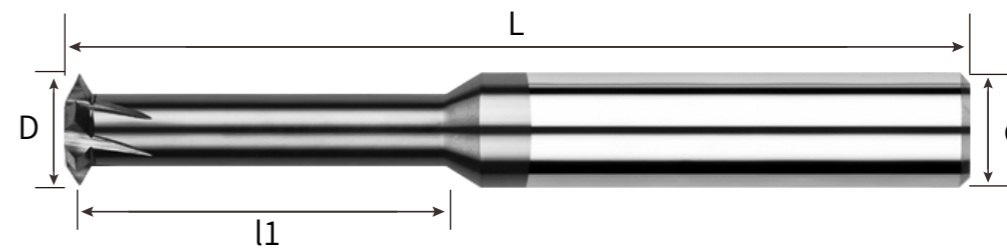

型号 Code No.	牙距 P	刃径 D	避空长度 l1	柄径 d	总长 L
YUSH-S0250350105	0.25-0.35	1.05	3.5	4	50
YUSH-S0250350120	0.25-0.35	1.2	4	4	50
YUSH-S03050155	0.3-0.5	1.55	6	4	50
YUSH-S03070196	0.3-0.7	1.96	6.5	4	50
YUSH-S03080235	0.3-0.8	2.35	8	4	50
YUSH-S03080315	0.3-0.8	3.15	10	4	50
YUSH-S0310039	0.3-1.0	3.9	12	4	50
YUSH-S0515048	0.5-1.5	4.8	15	6	50
YUSH-S05175060	0.5-1.75	6	20	6	50
YUSH-S0525077	0.5-2.5	7.7	25	8	60
YUSH-S1030096	1.0-3.0	9.6	30	10	75
YUSH-S1035100	1.0-3.5	10	36	10	75
YUSH-S1040120	1.0-4.0	12	38	12	75
YUSH-S1540140	1.5-4.0	14	48	14	100
YUSH-S2050160	2.0-5.0	16	50	16	100

可切削材料适用表 Applicable table for cutting materials

○ 非常合适 ○ 合适

碳素钢 carbon steel	合金钢 Alloy steel	预硬钢、淬硬钢 Prehardened steel, hardened steel				不锈钢 Stainless steel	铸铁 cast iron 球墨铸铁 Spheroidal graphite cast iron	铜合金 Copper alloy	铝合金 Aluminium alloy	钛合金 titanium alloy	耐热合金 Heat-resisting alloy
		~40HRC	~50HRC	~55HRC	~68HRC						
○	○	○	○	○	○	○	○	○	○	○	



Delivery  
交货期



请咨询  
Please ask



Order  
订货范例

Code No.  
YUSH-SL0508039

可切削材料适用表 Applicable table for cutting materials

○ 非常合适 ○ 合适

碳素钢 carbon steel	合金钢 Alloy steel	预硬钢、淬硬钢 Prehardened steel, hardened steel				不锈钢 Stainless steel	铸铁 cast iron 球墨铸铁 Spheroidal graphite cast iron	铜合金 Copper alloy	铝合金 Aluminium alloy	钛合金 titanium alloy	耐热合金 Heat-resisting alloy
		~40HRC	~50HRC	~55HRC	~68HRC						
○	○	○	○	○	○	○	○	○	○	○	



Delivery  
交货期



请咨询  
Please ask



Order  
订货范例

Code No.  
YUSH-S0250350105

YUSH

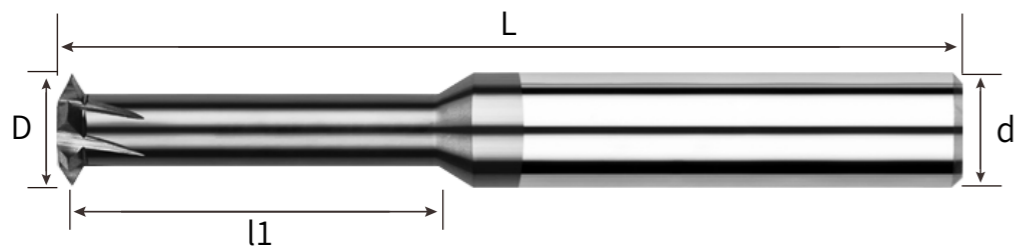

型号 Code No.	牙距 P	刃径 D	避空长度 l1	柄径 d	总长 L
YUSH-S08020055	M0.8*0.2	0.55	1.5	4	50
YUSH-S09022500625	M0.9*0.225	0.625	1.8	4	50
YUSH-S100250072	M1.0*0.25	0.72	2.5	4	50
YUSH-S120250090	M1.2*0.25	0.9	3.2	4	50
YUSH-S14030105	M1.4*0.3	1.05	3.5	4	50
YUSH-S160350120	M1.6*0.35	1.2	4	4	50
YUSH-S2004015506	M2.0*0.4	1.55	6	4	50
YUSH-S250450196	M2.5*0.45	1.96	6.5	4	50
YUSH-S30050235	M3.0*0.5	2.35	8	4	50
YUSH-S4007031510	M4.0*0.7	3.15	10	4	50
YUSH-S50080390	M5.0*0.8	3.9	12	4	50
YUSH-S60100480	M6.0*1.0	4.8	15	6	50
YUSH-S8012506020	M8.0*1.25	6	20	6	60
YUSH-S1015077	M10*1.5	7.7	25	8	60
YUSH-S12175096	M12*1.75	9.6	30	10	75
YUSH-S1420100	M14*2.0	10	36	10	75
YUSH-S1825120	M18*2.5	12	38	12	75
YUSH-S2430140	M24*3.0	14	48	14	100
YUSH-S3035160	M30*3.5	16	50	16	100

YUSH

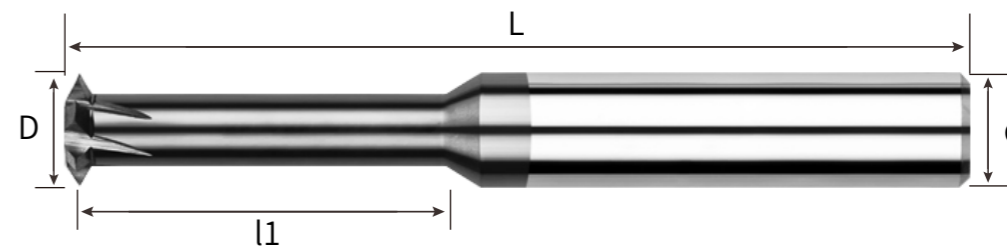

型号 型号	牙距 P	刃径 D	避空长度 l1	柄径 d	总长 L
YUSH-SL14030105	M1.4*0.3	1.05	3.5	4	100
YUSH-SL16035012	M1.6*0.35	1.2	4	4	100
YUSH-SL20040155	M2.0*0.4	1.55	6	4	100
YUSH-SL250450196	M2.5*0.45	1.96	6.5	4	100
YUSH-SL30050235	M3.0*0.5	2.35	8	4	100
YUSH-SL40070315	M4.0*0.7	3.15	10	4	100
YUSH-SL5008039	M5.0*0.8	3.9	12	4	100
YUSH-SL6010048	M6.0*1.0	4.8	15	6	100
YUSH-SL80125060	M8.0*1.25	6	20	6	100
YUSH-SL1015077	M10*1.5	7.7	25	8	100
YUSH-SL12175096	M12*1.75	9.6	30	10	100
YUSH-SL1420100	M14*2.0	10	36	10	100
YUSH-SL1825120	M18*2.5	12	38	12	100
YUSH-SL2430140	M24*3.0	14	48	14	100
YUSH-SL3035160	M30*3.5	16	50	16	100

可切削材料适用表 Applicable table for cutting materials

非常合适 合适

碳素钢 carbon steel	合金钢 Alloy steel	预硬钢、淬硬钢 Prehardened steel, hardened steel				不锈钢 Stainless steel	铸铁 cast iron 球墨铸铁 Spheroidal graphite cast iron	铜合金 Copper alloy	铝合金 Aluminium alloy	钛合金 titanium alloy	耐热合金 Heat-resisting alloy
		~40HRC	~50HRC	~55HRC	~68HRC						
○	○	○	○	○	○	○	○	○	○	○	

Delivery 交货期 请咨询 Please ask Order 订货范例 Code No. YUSH-S08020055

可切削材料适用表 Applicable table for cutting materials

非常合适 合适

碳素钢 carbon steel	合金钢 Alloy steel	预硬钢、淬硬钢 Prehardened steel, hardened steel				不锈钢 Stainless steel	铸铁 cast iron 球墨铸铁 Spheroidal graphite cast iron	铜合金 Copper alloy	铝合金 Aluminium alloy	钛合金 titanium alloy	耐热合金 Heat-resisting alloy
		~40HRC	~50HRC	~55HRC	~68HRC						
○	○	○	○	○	○	○	○	○	○	○	

Delivery 交货期 请咨询 Please ask Order 订货范例 Code No. YUSH-SL14030105

YUSH

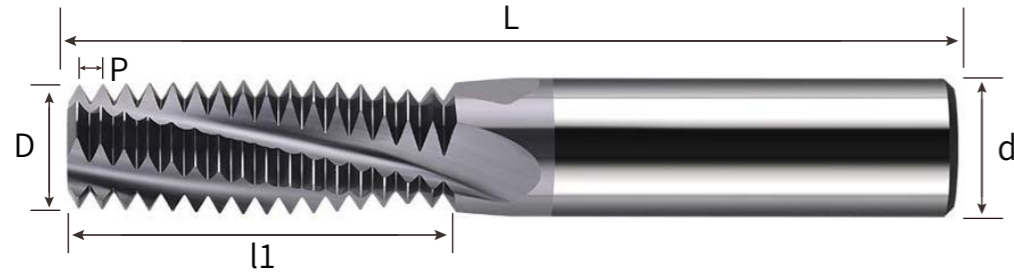

型号 Code No.	牙距 P	刃径 D	避空长度 l1	柄径 d	总长 L
YUSH-S20040155	M2*0.4	1.55	4	4	50
YUSH-S25045020	M2.5*0.45	2	5	4	50
YUSH-S3005024	M3*0.5	2.4	6	4	50
YUSH-S40070315	M4*0.7	3.15	8	4	50
YUSH-S5005040	M5*0.5	4	10	4	50
YUSH-S50075040	M5*0.75	4	10	4	50
YUSH-S5008040	M5*0.8	4	10	4	50
YUSH-S60075048	M6*0.75	4.8	12	6	60
YUSH-S6010048	M6*1.0	4.8	12	6	60
YUSH-S8005060	M8*0.5	6	16	6	60
YUSH-S80075060	M8*0.75	6	16	6	60
YUSH-S8010060	M8*1.0	6	16	6	60
YUSH-S80125060	M8*1.25	6	16	6	60
YUSH-S1010080	M10*1.0	8	20	8	60
YUSH-S10125080	M10*1.25	8	20	8	60
YUSH-S10150080	M10*1.5	8	20	8	60
YUSH-S1205100	M12*0.5	10	24	10	75
YUSH-S12075100	M12*0.75	10	24	10	75
YUSH-S1210100	M12*1.0	10	24	10	75
YUSH-S1212510	M12*1.25	10	24	10	75
YUSH-S1215100	M12*1.5	10	24	10	75
YUSH-S12175100	M12*1.75	10	24	10	75
YUSH-S1410120	M14*1.0	12	28	12	75
YUSH-S1415120	M14*1.5	12	28	12	75
YUSH-S1420116	M14*2.0	11.6	28	12	75
YUSH-S1615140	M16*1.5	14	32	14	100
YUSH-S1620130	M16*2.0	13	32	14	100
YUSH-S1825148	M18*2.5	14.8	38	16	100
YUSH-S2015160	M20*1.5	16	38	16	100
YUSH-S2025160	M20*2.5	16	42	16	100
YUSH-S2430160	M24*3.0	16	42	16	100

可切削材料适用表 Applicable table for cutting materials

非常合适 合适

碳素钢 carbon steel	合金钢 Alloy steel	预硬钢、淬硬钢 Prehardened steel, hardened steel				不锈钢 Stainless steel	铸铁 cast iron 球墨铸铁 Spheroidal graphite cast iron	铜合金 Copper alloy	铝合金 Aluminium alloy	钛合金 titanium alloy	耐热合金 Heat-resisting alloy
		~40HRC	~50HRC	~55HRC	~68HRC						
○	○	○	○	○	○	○	○		○	○	



Delivery  
交货期



请咨询  
Please ask



Order  
订货范例

Code No.  
YUSH-S20040155

YUSTA

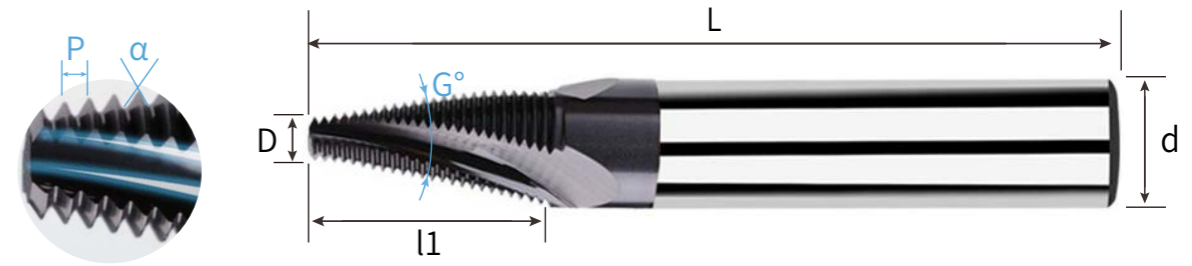

型号 Code No.	牙型角 α	牙距 P	刃径 D	刃长 l1	锥度 G	柄径 d	总长 L	刃数 F
YUSTA-S03019A60	60	P0.3	1.9	6	20	6	60	3
YUSTA-S04023A60	60	P0.4	2.3	10	20	6	60	3
YUSTA-S05029A60	60	P0.5	2.9	9	20	6	60	3
YUSTA-S06030A60	60	P0.6	3	14	20	8	60	3
YUSTA-S03019A55	55	P0.3	1.9	6	20	6	60	3
YUSTA-S04023A55	55	P0.4	2.3	10	20	6	60	3
YUSTA-S05029A55	55	P0.5	2.9	9	20	6	60	3
YUSTA-S06030A55	55	P0.6	3	14	20	8	60	3

可切削材料适用表 Applicable table for cutting materials

非常合适 合适

碳素钢 carbon steel	合金钢 Alloy steel	预硬钢、淬硬钢 Prehardened steel, hardened steel				不锈钢 Stainless steel	铸铁 cast iron 球墨铸铁 Spheroidal graphite cast iron	铜合金 Copper alloy	铝合金 Aluminium alloy	钛合金 titanium alloy	耐热合金 Heat-resisting alloy
		~40HRC	~50HRC	~55HRC	~68HRC						
						○			○	○	



Delivery  
交货期



请咨询  
Please ask



Order  
订货范例

Code No.  
YUSTA-S03019A60

YUSH

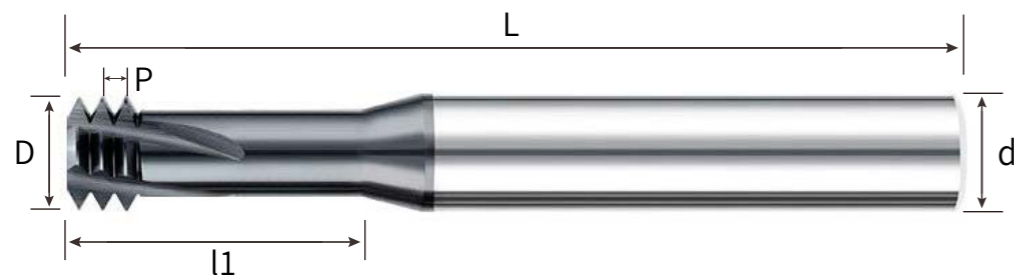

型号 Code No.	牙距 P	刃径 D	避空长度 l1	柄径 d	总长 L
YUSH-3S10025	M1.0*0.25	0.73	3	4	50
YUSH-3S12025	M1.2*0.25	0.92	3.6	4	50
YUSH-3S14030	M1.4*0.3	1.05	4.2	4	50
YUSH-3S16035	M1.6*0.35	1.2	4.8	4	50
YUSH-3S1603506	M1.6*0.35*D6	1.2	6	6	50
YUSH-3S2004	M2.0*0.4	1.55	6	4	50
YUSH-3S200406	M2.0*0.4*D6	1.55	7.5	6	50
YUSH-3S25045	M2.5*0.45	2	7.5	4	50
YUSH-3S2504506	M2.5*0.45*D6	2	7.5	6	50
YUSH-3S3005	M3.0*0.5	2.4	9	4	50
YUSH-3S300506	M3.0*0.5*D6	2.4	9	6	50
YUSH-3S4007	M4.0*0.7	3.15	12	4	50
YUSH-3S400706	M4.0*0.7*D6	3.15	12	6	50
YUSH-3S5008	M5.0*0.8	4	15	4	50
YUSH-3S500806	M5.0*0.8*D6	4	15	6	50
YUSH-3S6010	M6.0*1.0	4.8	18	6	50
YUSH-3S80125	M8*1.25	6	24	6	50
YUSH-3S100015	M10*1.5	8	30	8	60
YUSH-3S120175	M12*1.75	10	36	10	75

YUSH

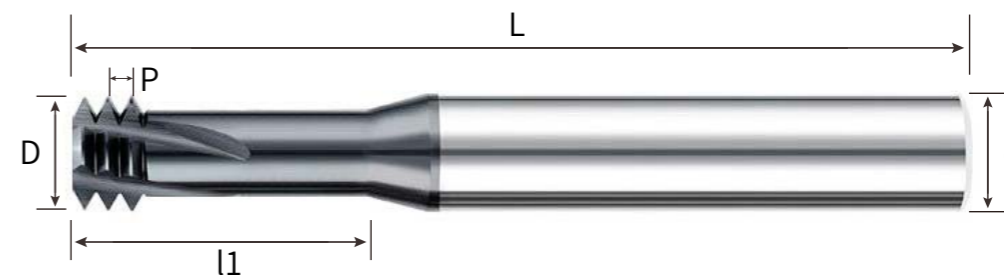

型号 Code No.	牙距 P	刃径 D	避空长度 l1	柄径 d	总长 L
YUSH-3SL035012032	M1.6*0.35	1.2	3.2	6	100
YUSH-3SL040155060	M2.0*0.4	1.55	6	6	75
YUSH-3SL040155040	M2.0*0.4	1.55	4	6	100
YUSH-3SL045020075	M2.5*0.45	2	7.5	6	75
YUSH-3SL045020050	M2.5*0.45	2	5	6	100
YUSH-3SL05024090	M3.0*0.5	2.4	9	6	75
YUSH-3SL05024060	M3.0*0.5	2.4	6	6	100
YUSH-3SL070315120	M4.0*0.7	3.15	12	6	75
YUSH-3SL070315080	M4.0*0.7	3.15	8	6	100
YUSH-3SL080405150	M5.0*0.8	4.05	15	6	75
YUSH-3SL080405100	M5.0*0.8	4.05	10	6	100
YUSH-3SL10048180	M6.0*1.0	4.8	18	6	75
YUSH-3SL10048120	M6.0*1.0	4.8	12	6	100
YUSH-3SL125060240	M8.0*1.25	6	24	6	75
YUSH-3SL125060160	M8.0*1.25	6	16	6	100
YUSH-3SL15080300	M10*1.5	8	30	8	75
YUSH-3SL15080200	M10*1.5	8	20	8	100
YUSH-3SL175100240	M12*1.75	10	24	10	100
YUSH-3SL20100280	M14*2.0	10	28	10	100

可切削材料适用表 Applicable table for cutting materials

○ 非常合适 ○ 合适

碳素钢 carbon steel	合金钢 Alloy steel	预硬钢、淬硬钢 Prehardened steel, hardened steel				不锈钢 Stainless steel	铸铁 cast iron 球墨铸铁 Spheroidal graphite cast iron	铜合金 Copper alloy	铝合金 Aluminium alloy	钛合金 titanium alloy	耐热合金 Heat-resisting alloy
		~40HRC	~50HRC	~55HRC	~68HRC						
○	○	○	○	○	○	○	○		○	○	

Delivery 交货期 | 请咨询 Please ask | Order 订货范例 | Code No. YUSH-3S10025

可切削材料适用表 Applicable table for cutting materials

○ 非常合适 ○ 合适

碳素钢 carbon steel	合金钢 Alloy steel	预硬钢、淬硬钢 Prehardened steel, hardened steel				不锈钢 Stainless steel	铸铁 cast iron 球墨铸铁 Spheroidal graphite cast iron	铜合金 Copper alloy	铝合金 Aluminium alloy	钛合金 titanium alloy	耐热合金 Heat-resisting alloy
		~40HRC	~50HRC	~55HRC	~68HRC						
○	○	○	○	○	○	○	○		○	○	

Delivery 交货期 | 请咨询 Please ask | Order 订货范例 | Code No. YUSH-3SL035012032

YUSH

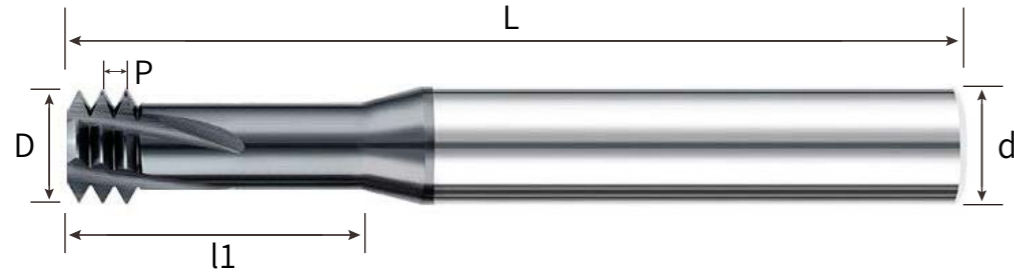

型号	牙距	刃径	避空长度	柄径	总长
Code No.	P	D	l1	d	L
YUSH-3S0250073020	M1.0*0.25	0.73	2	4	50
YUSH-3S0250092024	M1.2*0.25	0.92	2.4	4	50
YUSH-3S030105028	M1.4*0.3	1.05	2.8	4	50
YUSH-3S035012032	M1.6*0.35	1.2	3.2	4	50
YUSH-3S03501203206	M1.6*0.35	1.2	3.2	6	50
YUSH-3S035014036	M1.8*0.35	1.4	3.6	4	50
YUSH-3S040155040	M2.0*0.4	1.55	4	4	50
YUSH-3S04015504006	M2.0*0.4	1.55	4	6	50
YUSH-3S0450170050	M2.2*0.45	1.7	5	4	50
YUSH-3S045020050	M2.5*0.45	2	5	4	50
YUSH-3S04502005006	M2.5*0.45	2	5	6	50
YUSH-3S05024040	M3.0*0.5	2.4	6	4	50
YUSH-3S05024060	M3.0*0.5	2.4	6	6	50
YUSH-3S060275080	M3.5*0.6	2.75	8	4	50
YUSH-3S070315080	M4.0*0.7	3.15	8	4	50
YUSH-3S07031508006	M4.0*0.7	3.15	8	6	50
YUSH-3S075035090	M4.5*0.75	3.5	9	4	50
YUSH-3S08040100	M5.0*0.8	4	10	4	50
YUSH-3S0804010006	M5.0*0.8	4	10	6	50
YUSH-3S075048120	M6.0*0.75	4.8	12	6	50
YUSH-3S10048120	M6.0*1.0	4.8	12	6	50

YUSH

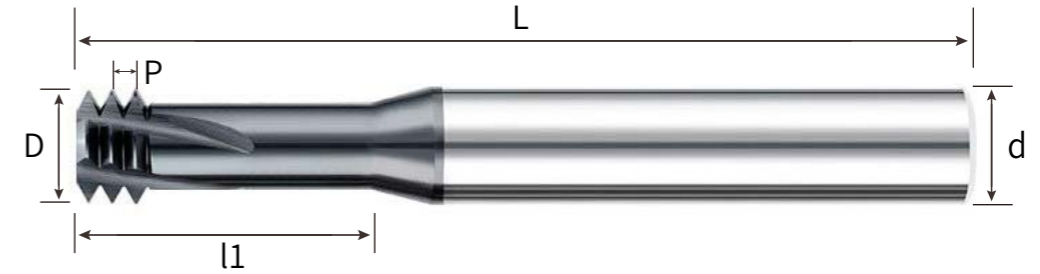

型号	牙距	刃径	避空长度	柄径	总长
Code No.	P	D	l1	d	L
YUSH-3S10060160	M8*1.0	6	16	6	50
YUSH-3S125060160	M8*1.25	6	16	6	50
YUSH-3S10080200	M10*1.0	8	20	8	60
YUSH-3S15080200	M10*1.5	8	20	8	60
YUSH-3S10100240	M12*1.0	10	24	10	75
YUSH-3S125100240	M12*1.25	10	24	10	75
YUSH-3S15100240	M12*1.5	10	24	10	75
YUSH-3S175100240	M12*1.75	10	24	10	75
YUSH-3S15120280	M14*1.5	12	28	12	75
YUSH-3S20100280	M14*2.0	10	28	10	75
YUSH-3S20120320	M16*2.0	12	32	12	75
YUSH-3S16140320	M16*1.5	14	32	14	100
YUSH-3S20135320	M16*2.0	13.5	32	16	100
YUSH-3S25148380	M18*2.5	14.8	38	16	100
YUSH-3S15160400	M20*1.5	16	40	16	100
YUSH-3S25160400	M20*2.5	16	40	16	100
YUSH-3S30160480	M24*3.0	16	48	16	100

可切削材料适用表 Applicable table for cutting materials

○ 非常合适 ○ 合适

碳素钢 carbon steel	合金钢 Alloy steel	预硬钢、淬硬钢 Prehardened steel, hardened steel				不锈钢 Stainless steel	铸铁 cast iron 球墨铸铁 Spheroidal graphite cast iron	铜合金 Copper alloy	铝合金 Aluminium alloy	钛合金 titanium alloy	耐热合金 Heat-resisting alloy
		~40HRC	~50HRC	~55HRC	~68HRC						
○	○	○	○	○	○	○	○	○	○	○	

Delivery 交货期 请咨询 Please ask Order 订货范例 Code No. YUSH-3S0250073020

可切削材料适用表 Applicable table for cutting materials

○ 非常合适 ○ 合适

碳素钢 carbon steel	合金钢 Alloy steel	预硬钢、淬硬钢 Prehardened steel, hardened steel				不锈钢 Stainless steel	铸铁 cast iron 球墨铸铁 Spheroidal graphite cast iron	铜合金 Copper alloy	铝合金 Aluminium alloy	钛合金 titanium alloy	耐热合金 Heat-resisting alloy
		~40HRC	~50HRC	~55HRC	~68HRC						
○	○	○	○	○	○	○	○	○	○	○	

Delivery 交货期 请咨询 Please ask Order 订货范例 Code No. YUSH-3S0250073020

YUSH

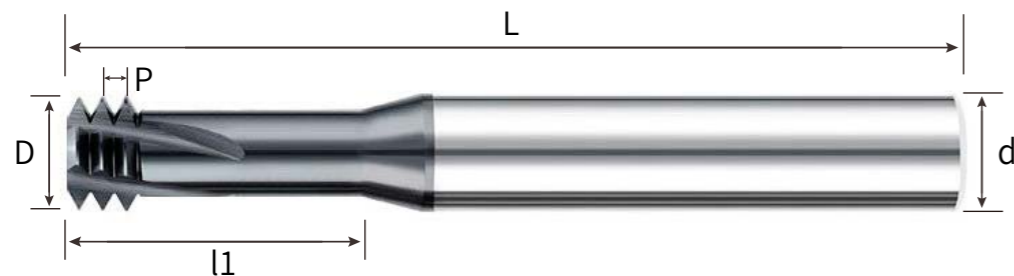

型号 Code No.	牙距 P	刃径 D	避空长度 l1	柄径 d	总长 L
YUSH-3SL040155080	M2*0.4	1.55	8	4	50
YUSH-3SL045020100	M2.5*0.45	2	10	4	50
YUSH-3SL05024120	M3.0*0.5	2.4	12	4	50
YUSH-3SL070315160	M4.0*0.7	3.15	16	4	50
YUSH-3SL08040200	M5.0*0.8	4	20	4	50

YUSH

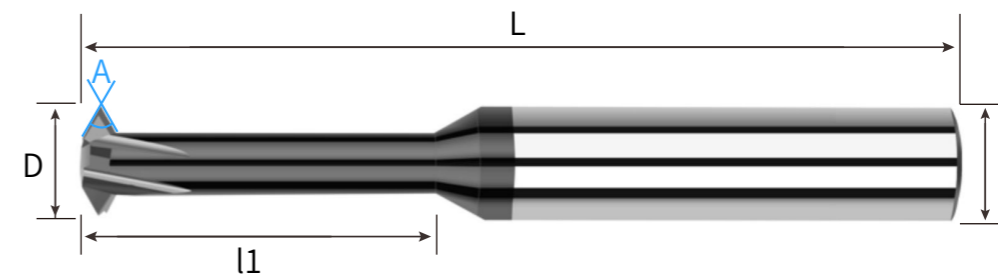

型号 Code No.	牙距 P	角度 A	刃径 D	避空长度 l1	柄径 d	总长 L
YUSH-SG32-A55	P0.7937	55	3.1	8	4	50
YUSH-SG24-A55	P1.058	55	3.5	10	4	50
YUSH-SG20-A55	P1.27	55	4	12	4	50
YUSH-SG28-18-A55	P0.907-P1.411	55	6	14	6	50
YUSH-SG19-A55	P1.336-P1.814	55	8	22	8	60
YUSH-SG19-14-A55	P1.336-P1.814	55	10	30	10	75
YUSH-SG14-10-A55	P1.336-P2.54	55	12	38	12	75

可切削材料适用表 Applicable table for cutting materials

非常合适 合适

碳素钢 carbon steel	合金钢 Alloy steel	预硬钢、淬硬钢 Prehardened steel, hardened steel				不锈钢 Stainless steel	铸铁 cast iron 球墨铸铁 Spheroidal graphite cast iron	铜合金 Copper alloy	铝合金 Aluminium alloy	钛合金 titanium alloy	耐热合金 Heat-resisting alloy
		~40HRC	~50HRC	~55HRC	~68HRC						
○	○	○	○	○	○	○	○	○	○	○	

Delivery 交货期 请咨询 Please ask Order 订货范例 Code No. YUSH-3SL040155080

可切削材料适用表 Applicable table for cutting materials

非常合适 合适

碳素钢 carbon steel	合金钢 Alloy steel	预硬钢、淬硬钢 Prehardened steel, hardened steel				不锈钢 Stainless steel	铸铁 cast iron 球墨铸铁 Spheroidal graphite cast iron	铜合金 Copper alloy	铝合金 Aluminium alloy	钛合金 titanium alloy	耐热合金 Heat-resisting alloy
		~40HRC	~50HRC	~55HRC	~68HRC						
○	○	○	○	○	○	○	○	○	○	○	

Delivery 交货期 请咨询 Please ask Order 订货范例 Code No. YUSH-SG32-A55

### YUSMJ

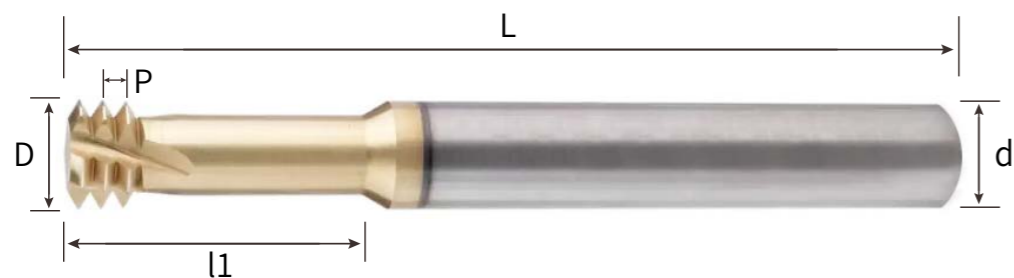

型号 Code No.	牙距 P	刃径 D	避空长度 l1	柄径 d	总长 L
YUSMJ-S040155	MJ2.0*0.4	1.55	6	4	50
YUSMJ-S045020	MJ2.5*0.45	2	7.5	4	50
YUSMJ-S05024	MJ3.0*0.5	2.4	9	4	50
YUSMJ-S070315	MJ4.0*0.7	3.15	12	4	50
YUSMJ-S08040	MJ5.0*0.8	4	15	4	50
YUSMJ-S10048	MJ6.0*1.0	4.8	18	6	50
YUSMJ-S125060	MJ8*1.25	6	24	6	50
YUSMJ-S15080	M10*1.5	8	30	8	60
YUSMJ-S175100	M12*1.75	10	36	10	75

### YUSUNF

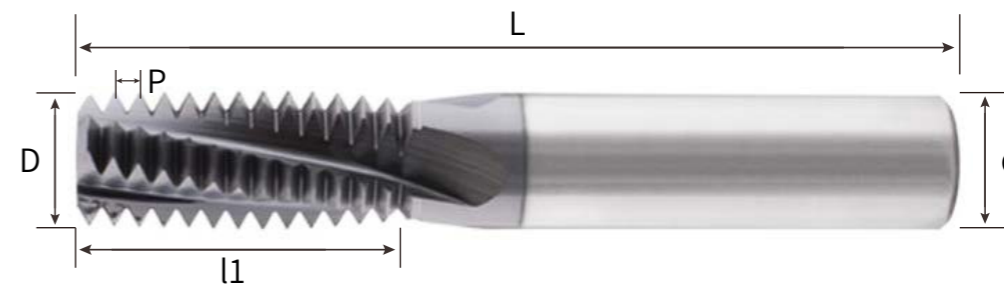

型号 Code No.	牙型 M	牙距 P	刃径 D	刃长 H	柄径 d	总长 L
YUSUNF-T32	细	10-32	3.9	10	4	50
YUSUNF-T28	细	1/4-28	5.3	12	6	60
YUSUNF-T24	细	5/16-24	6.5	18	8	60
YUSUNF-T20	细	7/16-20	9.5	24	10	75
YUSUNF-T18	细	9/16-18	10	24	10	75
YUSUNF-T16	细	3/4-16	12	28	12	75
YUSUNC-T20	粗	1/4-20	4.85	12	6	60
YUSUNC-T18	粗	5/16-18	6.4	18	8	60
YUSUNC-T16	粗	3/8-16	7.8	21	8	60
YUSUNC-T14	粗	7/16-14	8.8	24	10	75
YUSUNC-T12	粗	9/16-12	12	28	12	75
YUSUNC-T13	粗	1/2-13	10	24	10	75
YUSUNC-T11	粗	5/8-11	12	28	12	75
YUSUNC-T10	粗	3/4-10	16	38	38	100
YUSUNC-T9	粗	7/8-9	16	38	16	100

#### 可切削材料适用表 Applicable table for cutting materials

○ 非常合适 ○ 合适

碳素钢 carbon steel	合金钢 Alloy steel	预硬钢、淬硬钢 Prehardened steel, hardened steel				不锈钢 Stainless steel	铸铁 cast iron 球墨铸铁 Spheroidal graphite cast iron	铜合金 Copper alloy	铝合金 Aluminium alloy	钛合金 titanium alloy	耐热合金 Heat-resisting alloy
		~40HRC	~50HRC	~55HRC	~68HRC						
	○	○	○	○			○	○	○	○	



Delivery  
交货期



请咨询  
Please ask



Order  
订货范例

Code No.  
YUSMJ-S040155

#### 可切削材料适用表 Applicable table for cutting materials

○ 非常合适 ○ 合适

碳素钢 carbon steel	合金钢 Alloy steel	预硬钢、淬硬钢 Prehardened steel, hardened steel				不锈钢 Stainless steel	铸铁 cast iron 球墨铸铁 Spheroidal graphite cast iron	铜合金 Copper alloy	铝合金 Aluminium alloy	钛合金 titanium alloy	耐热合金 Heat-resisting alloy
		~40HRC	~50HRC	~55HRC	~68HRC						
○	○	○	○	○			○	○	○	○	



Delivery  
交货期



请咨询  
Please ask



Order  
订货范例

Code No.  
YUSUNF-T32



YUSUNC

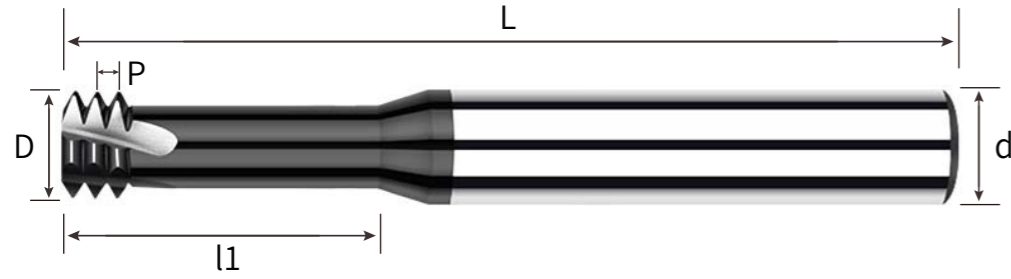

型号	螺纹牙型	牙距	刃径	避空长度	柄径	总长
Code No.	M	P	D	l1	d	L
YUSUNC-3T64	粗	NO.1-64	1.4	4	4	50
YUSUNC-3T56	粗	NO.2-56	1.65	5	4	50
YUSUNC-3T48	粗	NO.3-48	1.95	5	4	50
YUSUNC-3T40	粗	NO.4-40	2.15	6	4	50
YUSUNC-3LT40	粗	NO.5-40	2.45	7.2	4	50
YUSUNC-3T32	粗	NO.6-32	2.65	7.5	4	50
YUSUNC-3LT32	粗	NO.8-32	3.2	9	4	50
YUSUNC-3T24	粗	NO.10-24	3.7	10	4	50
YUSUNC-3T20	粗	1/4-20	4.9	12	6	50
YUSUNC-3T16	粗	3/8-16	7.8	20	8	60
YUSUNC-3T18	粗	5/16-18	6.4	18	8	60
YUSUNC-3T14	粗	7/16-14	9.2	24	10	75
YUSUNC-3T13	粗	1/2-13	10	24	10	75
YUSUNF-3T72	细	NO.1-72	1.45	3.9	4	50
YUSUNF-3T56	细	NO.3-56	1.95	5.3	4	50
YUSUNF-3T48	细	NO.4-48	2.25	6	4	50
YUSUNF-3T40	细	NO.6-40	2.75	7.2	4	50
YUSUNF-3T36	细	NO.8-36	3.3	8.7	4	50
YUSUNF-3T32	细	NO.10-32	3.9	10	4	50
YUSUNF-3T28	细	1/4-28	5.3	12	6	50
YUSUNF-3T20	细	7/16-20	9.5	24	10	75

YUSBSP

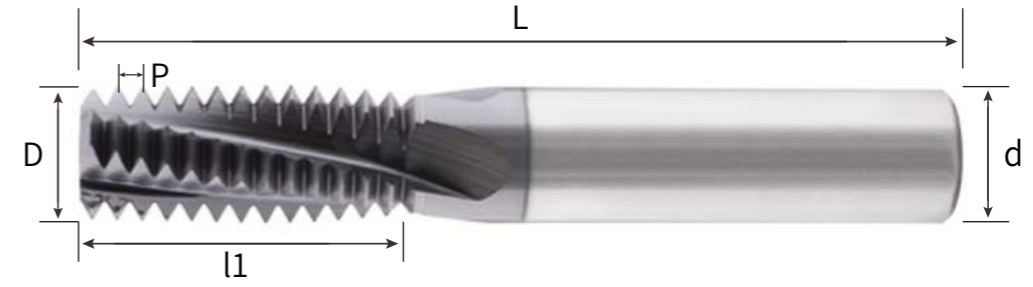

型号	牙距	刃径	刃长	柄径	总长
Code No.	P	D	H	d	L
YUSBSP-ST28060	1/16-28	6	14	6	60
YUSBSP-ST28080	1/8-28	8	14	8	60
YUSBSP-ST19080	1/4-19	8	18	8	60
YUSBSP-ST19100	1/4-19	10	20	10	75
YUSBSP-SLT19100	1/4-19	10	24	10	75
YUSBSP-ST19120	3/8-19	12	25	12	75
YUSBSP-SLT19120	3/8-19	12	28	12	75
YUSBSP-ST14120	1/2-14	12	20	12	75
YUSBSP-SLT14120	1/2-14	12	28	12	75
YUSBSP-ST14160	3/4-14	16	30	16	100
YUSBSP-ST11160	1"-11	16	32	16	100
YUSBSP-SLT11160	1"-11	16	38	16	100
YUSBSP-ST11200	1"-11	20	42	20	100

可切削材料适用表 Applicable table for cutting materials

非常合适 合适

碳素钢 carbon steel	合金钢 Alloy steel	预硬钢、淬硬钢 Prehardened steel, hardened steel				不锈钢 Stainless steel	铸铁 cast iron 球墨铸铁 Spheroidal graphite cast iron	铜合金 Copper alloy	铝合金 Aluminium alloy	钛合金 titanium alloy	耐热合金 Heat-resisting alloy
		~40HRC	~50HRC	~55HRC	~68HRC						
	○	○	○	○			○	○	○	○	

Delivery 交货期 请咨询 Please ask Order 订货范例 Code No. YUSUNC-3T64

可切削材料适用表 Applicable table for cutting materials

非常合适 合适

碳素钢 carbon steel	合金钢 Alloy steel	预硬钢、淬硬钢 Prehardened steel, hardened steel				不锈钢 Stainless steel	铸铁 cast iron 球墨铸铁 Spheroidal graphite cast iron	铜合金 Copper alloy	铝合金 Aluminium alloy	钛合金 titanium alloy	耐热合金 Heat-resisting alloy
		~40HRC	~50HRC	~55HRC	~68HRC						
○	○	○	○	○	○	○	○	○	○	○	

Delivery 交货期 请咨询 Please ask Order 订货范例 Code No. YUSBSP-ST28060

### YUSBSPT

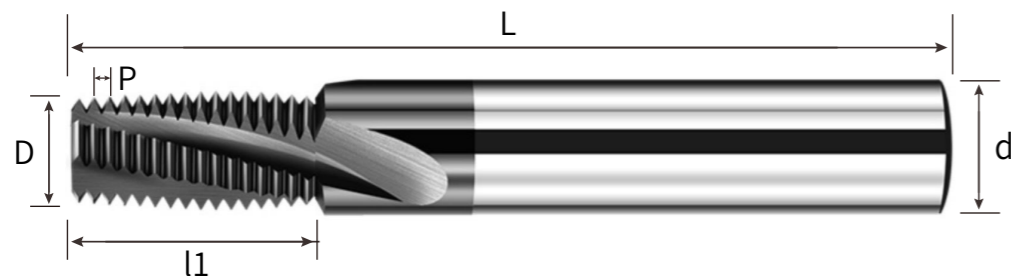

型号	牙距	刃径	刃长	柄径	总长
Code No.	P	D	H	d	L
YUSBSPT-T28053	1/16-28	5.3	9.9	6	60
YUSBSPT-T28073	1/8-28	7.3	9.9	8	60
YUSBSPT-T280675	1/8-28	6.75	20	8	60
YUSBSPT-T19070	1/4-19	7	14	8	60
YUSBSPT-T19090	1/4-19	9	15	10	75
YUSBSPT-T19085	1/4-19	8.5	24	10	75
YUSBSPT-T19110	3/8-19	11	14	12	75
YUSBSPT-T191025	3/8-19	10.25	28	12	75
YUSBSPT-T14108	1/2-14	10.8	19	12	75
YUSBSPT-T14102	1/2-14	10.2	28	12	75
YUSBSPT-T14146	3/4-14	14.6	21	16	100
YUSBSPT-T11143	1"-11	14.3	27	16	100
YUSBSPT-T111738	1"-11	17.38	42	20	100

### YUSM

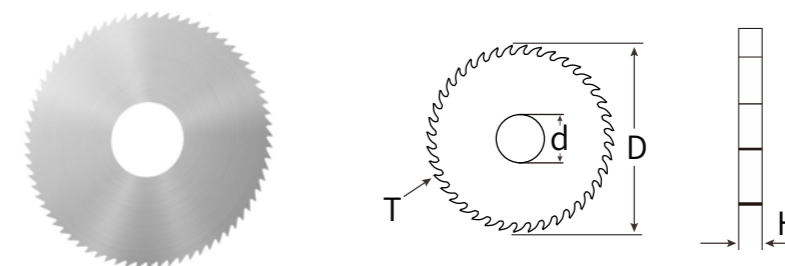

直径	厚度													内孔	齿数
	H														
16	0.3	0.4	0.5	0.6	0.8	1.0	1.2	1.5	1.8	2.0	2.5	2.8	3.0	5	30
20	0.3	0.5	0.6	0.8	1.0	1.2	1.5	1.8	2.0	2.5	2.8	3.0		6	40
25	0.3	0.5	0.6	0.8	1.0	1.2	1.5	1.8	2.0	2.5	2.8	3.0		8	40
30	0.3	0.5	0.6	0.8	1.0	1.2	1.5	1.8	2.0	2.5	2.8	3.0		10	40
40	0.3	0.5	0.6	0.8	1.0	1.2	1.5	1.8	2.0	2.5	2.8	3.0	13	24	
														40	
50	0.3	0.5	0.6	0.8	1.0	1.2	1.5	1.8	2.0	2.2	2.5	3.0	13	24	
														50	
60	0.4	0.5	0.6	0.8	1.0	1.2	1.5	1.8	2.0	2.2	2.5	2.8	13	30	
													16	60	
75	0.5	0.6	0.8	1.0	1.2	1.5	1.8	2.0	2.2	2.5	3.0	22	72		
													0.5	22	36
80	0.5	0.6	0.8	1.0	1.2	1.5	1.8	2.0	2.2	2.5	2.8	3.0	22	36	
														72	
90	0.6	0.8	1.0	1.2	1.5	2.0							22	90	
100	0.5	0.8	1.0	1.2	1.5	1.8	2.0	2.2	2.5				22	60	
													27	72	
														100	

#### 可切削材料适用表 Applicable table for cutting materials

○ 非常合适 ○ 合适

碳素钢 carbon steel	合金钢 Alloy steel	预硬钢、淬硬钢 Prehardened steel, hardened steel				不锈钢 Stainless steel	铸铁 cast iron 球墨铸铁 Spheroidal graphite cast iron	铜合金 Copper alloy	铝合金 Aluminium alloy	钛合金 titanium alloy	耐热合金 Heat-resisting alloy
		~40HRC	~50HRC	~55HRC	~68HRC						
○	○	○	○	○	○	○	○	○	○	○	

Delivery 交货期 请咨询 Please ask Order 订货范例 Code No. YUSBSPT-T28053

#### 可切削材料适用表 Applicable table for cutting materials

○ 非常合适 ○ 合适

碳素钢 carbon steel	合金钢 Alloy steel	预硬钢、淬硬钢 Prehardened steel, hardened steel				不锈钢 Stainless steel	铸铁 cast iron 球墨铸铁 Spheroidal graphite cast iron	铜合金 Copper alloy	铝合金 Aluminium alloy	钛合金 titanium alloy	耐热合金 Heat-resisting alloy
		~40HRC	~50HRC	~55HRC	~68HRC						
○	○	○	○	○	○	○	○	○	○	○	

Delivery 交货期 请咨询 Please ask Order 订货范例 Code No. YUSM-1603003

YEAE

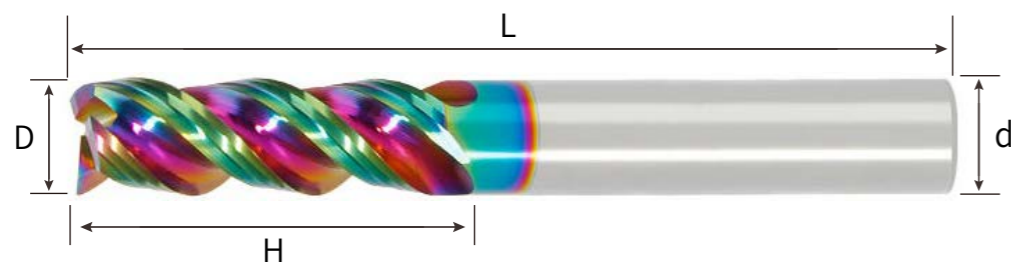

型号 Code No.	刃径 D	刃长 H	柄径 d	总长 L	刃数 T
YEAE-3S010	1	3	4	50	3
YEAE-3S015	1.5	4.5	4	50	3
YEAE-3S020	2	6	4	50	3
YEAE-3S025	2.5	7.5	4	50	3
YEAE-3S030	3	9	4	50	3
YEAE-3S035	3.5	10.5	4	50	3
YEAE-3S040	4	12	4	50	3
YEAE-3L040	4	16	4	75	3
YEAE-3XL040	4	20	4	100	3
YEAE-3S050	5	15	5	50	3
YEAE-3S0506	5	15	6	50	3
YEAE-3S060	6	18	6	50	3
YEAE-3L060	6	25	6	75	3
YEAE-3XL060	6	30	6	100	3
YEAE-3S080	8	24	8	60	3
YEAE-3L080	8	30	8	75	3
YEAE-3XL080	8	35	8	100	3
YEAE-3S100	10	30	10	75	3
YEAE-3L100	10	40	10	100	3
YEAE-3S120	12	36	12	75	3
YEAE-3L120	12	45	12	100	3
YEAE-3S140	14	45	14	100	3
YEAE-3S160	16	45	16	100	3
YEAE-3S200	20	50	20	100	3

YUSP

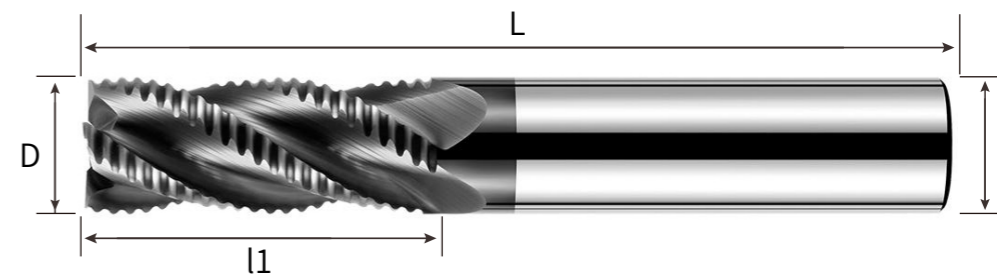

型号 Code No.	刃径 D	刃长 H	柄径 d	总长 L	刃数 T
YUSP-4S040	4	12	4	50	4
YUSP-4S050	5	15	6	50	4
YUSP-4S060	6	18	6	50	4
YUSP-4L060	6	24	6	75	4
YUSP-4XL060	6	30	6	100	4
YUSP-4S080	8	24	8	60	4
YUSP-4L080	8	30	8	75	4
YUSP-4XL080	8	35	8	100	4
YUSP-4S100	10	30	10	75	4
YUSP-4L100	10	45	10	100	4
YUSP-4XL100	10	60	10	150	4
YUSP-4S120	12	35	12	75	4
YUSP-4L120	12	45	12	100	4
YUSP-4XL120	12	60	12	150	4
YUSP-4S140	14	45	14	100	4
YUSP-4S160	16	45	16	100	4
YUSP-4L160	16	70	16	150	4
YUSP-4S180	18	45	18	100	4
YUSP-4S200	20	45	20	100	4

可切削材料适用表 Applicable table for cutting materials

非常合适 合适

碳素钢 carbon steel	合金钢 Alloy steel	预硬钢、淬硬钢 Prehardened steel, hardened steel				不锈钢 Stainless steel	铸铁 cast iron 球墨铸铁 Spheroidal graphite cast iron	铜合金 Copper alloy	铝合金 Aluminium alloy	钛合金 titanium alloy	耐热合金 Heat-resisting alloy
		~40HRC	~50HRC	~55HRC	~68HRC						

Delivery 交货期 请咨询 Please ask Order 订货范例 Code No. YEAE-3S010

可切削材料适用表 Applicable table for cutting materials

非常合适 合适

碳素钢 carbon steel	合金钢 Alloy steel	预硬钢、淬硬钢 Prehardened steel, hardened steel				不锈钢 Stainless steel	铸铁 cast iron 球墨铸铁 Spheroidal graphite cast iron	铜合金 Copper alloy	铝合金 Aluminium alloy	钛合金 titanium alloy	耐热合金 Heat-resisting alloy
		~40HRC	~50HRC	~55HRC	~68HRC						

Delivery 交货期 请咨询 Please ask Order 订货范例 Code No. YUSP-4S040

YESE

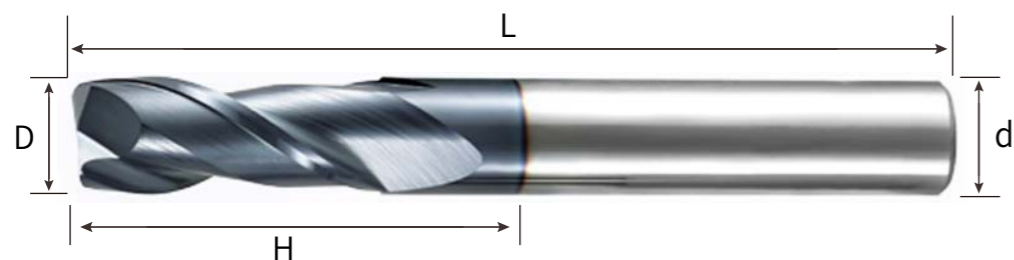

型号 Code No.	刃径 D	刃长 H	柄径 d	总长 L	刃数 T
YUSE-2S010	1	3	4	50	2
YUSE-2S015	1.5	4.5	4	50	2
YUSE-2S020	2	6	4	50	2
YUSE-2S025	2.5	7.5	4	50	2
YUSE-2S030	3	9	4	50	2
YUSE-2S0303	3	9	3	50	2
YUSE-2L030	3	12	4	75	2
YUSE-2XL030	3	15	4	100	2
YUSE-2S035	3.5	10	4	50	2
YUSE-2S040	4	12	4	50	2
YUSE-2L040	4	16	4	75	2
YUSE-2XL040	4	20	4	100	2
YUSE-2S0506	5	15	6	50	2
YUSE-2S050	5	15	5	50	2
YUSE-2L050	5	20	5	75	2
YUSE-2XL050	5	25	6	100	2
YUSE-2S060	6	18	6	50	2
YUSE-2L060	6	24	6	75	2
YUSE-2XL060	6	30	6	100	2
YUSE-2S080	8	24	8	60	2
YUSE-2L080	8	30	8	75	2
YUSE-2XL080	8	35	8	100	2

YUSE

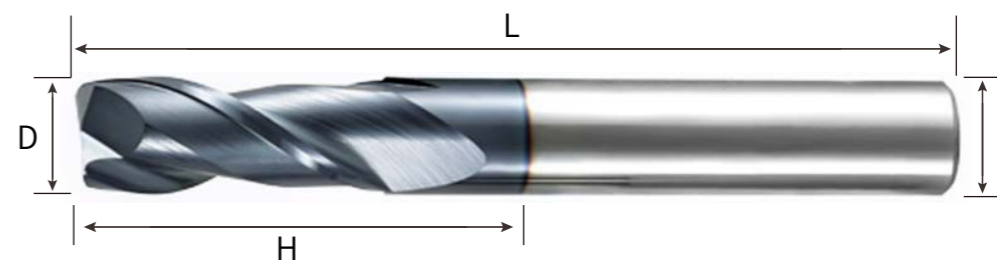

型号 Code No.	刃径 D	刃长 H	柄径 d	总长 L	刃数 T
YUSE-2S100	10	30	10	75	2
YUSE-2L100	10	45	10	100	2
YUSE-2S120	12	35	12	75	2
YUSE-2L120	12	45	12	100	2
YUSE-2S140	14	45	14	100	2
YUSE-2S160	16	45	16	100	2
YUSE-2S180	18	45	18	100	2
YUSE-2S200	20	45	20	100	2
YUSE-2XLL060	6	45	6	150	2
YUSE-2XLL080	8	50	8	150	2
YUSE-2XL100	10	60	10	150	2
YUSE-2XL120	12	60	12	150	2
YUSE-2XL140	14	70	14	150	2
YUSE-2XL160	16	75	16	150	2
YUSE-2XL180	18	75	18	150	2
YUSE-2XL200	20	75	20	150	2

可切削材料适用表 Applicable table for cutting materials

非常合适 合适

碳素钢 carbon steel	合金钢 Alloy steel	预硬钢、淬硬钢 Prehardened steel, hardened steel				不锈钢 Stainless steel	铸铁 cast iron 球墨铸铁 Spheroidal graphite cast iron	铜合金 Copper alloy	铝合金 Aluminium alloy	钛合金 titanium alloy	耐热合金 Heat-resisting alloy
		~40HRC	~50HRC	~55HRC	~68HRC						
○	○	○	○	○	○	○	○	○	○	○	

Delivery 交货期 | 请咨询 Please ask | Order 订货范例 | Code No. YUSE-2S010

可切削材料适用表 Applicable table for cutting materials

非常合适 合适

碳素钢 carbon steel	合金钢 Alloy steel	预硬钢、淬硬钢 Prehardened steel, hardened steel				不锈钢 Stainless steel	铸铁 cast iron 球墨铸铁 Spheroidal graphite cast iron	铜合金 Copper alloy	铝合金 Aluminium alloy	钛合金 titanium alloy	耐热合金 Heat-resisting alloy
		~40HRC	~50HRC	~55HRC	~68HRC						
○	○	○	○	○	○	○	○	○	○	○	

Delivery 交货期 | 请咨询 Please ask | Order 订货范例 | Code No. YUSE-2S010

YESE

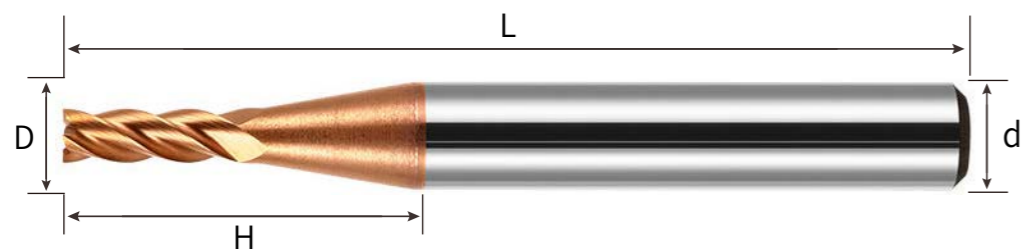

型号	刃径	刃长	柄径	总长	刃数
Code No.	D	H	d	L	T
YUSE-4S0105	1.05	3.3	4	50	4
YUSE-4S0110	1.1	3.3	4	50	4
YUSE-4S0115	1.15	3.6	4	50	4
YUSE-4S0120	1.2	3.6	4	50	4
YUSE-4S0125	1.25	3.9	4	50	4
YUSE-4S0130	1.3	3.9	4	50	4
YUSE-4S0135	1.35	4.2	4	50	4
YUSE-4S0140	1.4	4.2	4	50	4
YUSE-4S0145	1.45	4.5	4	50	4
YUSE-4S0155	1.55	4.8	4	50	4
YUSE-4S0160	1.6	4.8	4	50	4
YUSE-4S0165	1.65	5.1	4	50	4
YUSE-4S0170	1.7	5.1	4	50	4
YUSE-4S0175	1.75	5.4	4	50	4
YUSE-4S0180	1.8	5.4	4	50	4
YUSE-4S0185	1.85	5.7	4	50	4
YUSE-4S0190	1.9	5.7	4	50	4
YUSE-4S0195	1.95	6	4	50	4
YUSE-4S0205	2.05	6.3	4	50	4
YUSE-4S0210	2.1	6.3	4	50	4
YUSE-4S0215	2.15	6.6	4	50	4
YUSE-4S0220	2.2	6.6	4	50	4
YUSE-4S0225	2.25	6.9	4	50	4
YUSE-4S0230	2.3	6.9	4	50	4
YUSE-4S0235	2.35	7.2	4	50	4
YUSE-4S0240	2.4	7.2	4	50	4
YUSE-4S0245	2.45	7.5	4	50	4
YUSE-4S0255	2.55	7.8	4	50	4
YUSE-4S0260	2.6	7.8	4	50	4
YUSE-4S0265	2.65	8.1	4	50	4

YUSE

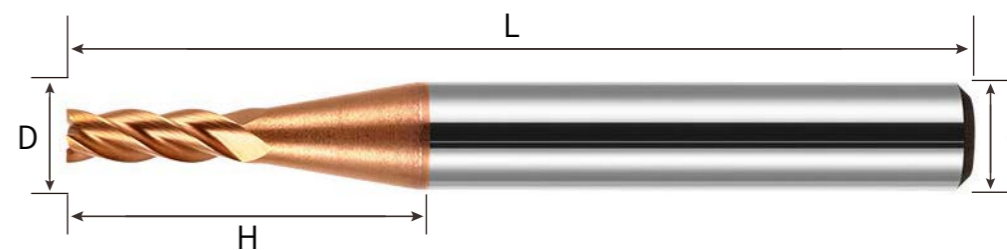

型号	刃径	刃长	柄径	总长	刃数
Code No.	D	H	d	L	T
YUSE-4S0270	2.7	8.1	4	50	4
YUSE-4S0275	2.75	8.4	4	50	4
YUSE-4S0280	2.8	8.4	4	50	4
YUSE-4S0285	2.85	8.7	4	50	4
YUSE-4S0290	2.9	8.7	4	50	4
YUSE-4S0295	2.95	9	4	50	4
YUSE-4S0305	3.05	9.3	4	50	4
YUSE-4S0310	3.1	9.3	4	50	4
YUSE-4S0315	3.15	9.6	4	50	4
YUSE-4S0320	3.2	9.6	4	50	4
YUSE-4S0325	3.25	9.9	4	50	4
YUSE-4S0330	3.3	9.9	4	50	4
YUSE-4S0335	3.35	10	4	50	4
YUSE-4S0340	3.4	10	4	50	4
YUSE-4S0345	3.45	10	4	50	4
YUSE-4S0355	3.55	10	4	50	4
YUSE-4S0360	3.6	10	4	50	4
YUSE-4S0365	3.65	10	4	50	4
YUSE-4S0370	3.7	10	4	50	4
YUSE-4S0375	3.75	10	4	50	4
YUSE-4S0380	3.8	10	4	50	4
YUSE-4S0385	3.85	10	4	50	4
YUSE-4S0390	3.9	10	4	50	4
YUSE-4S0395	3.95	10	4	50	4
YUSE-4S0410	4.1	10	6	50	4
YUSE-4S0420	4.2	10	6	50	4
YUSE-4S0430	4.3	11	6	50	4
YUSE-4S0440	4.4	11	6	50	4
YUSE-4S0450	4.5	11	6	50	4
YUSE-4S0460	4.6	12	6	50	4

YESE

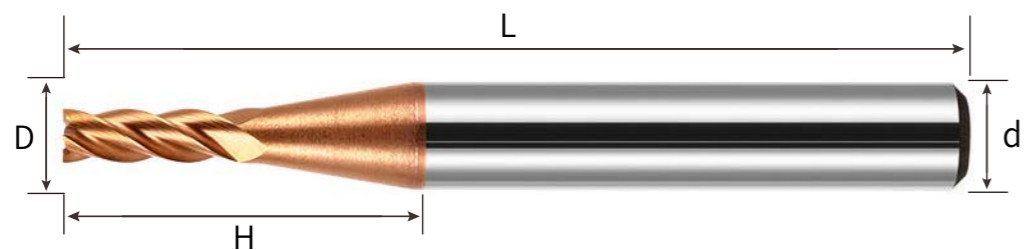

型号	刃径	刃长	柄径	总长	刃数
Code No.	D	H	d	L	T
YUSE-4S0470	4.7	12	6	50	4
YUSE-4S0480	4.8	12	6	50	4
YUSE-4S0490	4.9	13	6	50	4
YUSE-4S0510	5.1	13	6	50	4
YUSE-4S0520	5.2	13	6	50	4
YUSE-4S0530	5.3	13	6	50	4
YUSE-4S0540	5.4	13	6	50	4
YUSE-4S0550	5.5	14	6	50	4
YUSE-4S0560	5.6	14	6	50	4
YUSE-4S0570	5.7	14	6	50	4
YUSE-4S0580	5.8	15	6	50	4
YUSE-4S0590	5.9	15	6	50	4
YUSE-4S0610	6.1	15	8	60	4
YUSE-4S0620	6.2	15	8	60	4
YUSE-4S0630	6.3	16	8	60	4
YUSE-4S0640	6.4	16	8	60	4
YUSE-4S0650	6.5	16	8	60	4
YUSE-4S0660	6.6	16	8	60	4
YUSE-4S0670	6.7	17	8	60	4
YUSE-4S0680	6.8	17	8	60	4
YUSE-4S0690	6.9	17	8	60	4
YUSE-4S0710	7.1	17	8	60	4
YUSE-4S0720	7.2	18	8	60	4
YUSE-4S0730	7.3	18	8	60	4
YUSE-4S0740	7.4	18	8	60	4
YUSE-4S0750	7.5	18	8	60	4
YUSE-4S0760	7.6	19	8	60	4
YUSE-4S0770	7.7	19	8	60	4
YUSE-4S0780	7.8	19	8	60	4
YUSE-4S0790	7.9	19	8	60	4

YUSE

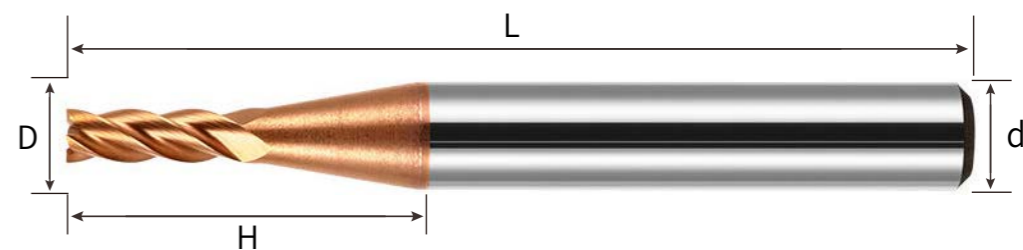

型号	刃径	刃长	柄径	总长	刃数
Code No.	D	H	d	L	T
YUSE-4S0810	8.1	20	10	75	4
YUSE-4S0820	8.2	20	10	75	4
YUSE-4S0830	8.3	20	10	75	4
YUSE-4S0840	8.4	21	10	75	4
YUSE-4S0850	8.5	21	10	75	4
YUSE-4S0860	8.6	21	10	75	4
YUSE-4S0870	8.7	22	10	75	4
YUSE-4S0880	8.8	22	10	75	4
YUSE-4S0890	8.9	22	10	75	4
YUSE-4S0910	9.1	23	10	75	4
YUSE-4S0920	9.2	23	10	75	4
YUSE-4S0930	9.3	23	10	75	4
YUSE-4S0940	9.4	23	10	75	4
YUSE-4S0950	9.5	24	10	75	4
YUSE-4S0960	9.6	24	10	75	4
YUSE-4S0970	9.7	24	10	75	4
YUSE-4S0980	9.8	24	10	75	4
YUSE-4S0990	9.9	25	10	75	4
YUSE-4S10010	10.1	25	12	75	4
YUSE-4S10020	10.2	25	12	75	4
YUSE-4S10030	10.3	25	12	75	4
YUSE-4S10040	10.4	26	12	75	4
YUSE-4S10050	10.5	26	12	75	4
YUSE-4S10060	10.6	26	12	75	4
YUSE-4S10070	10.7	26	12	75	4
YUSE-4S10080	10.8	27	12	75	4
YUSE-4S10090	10.9	27	12	75	4
YUSE-4S11000	11	27	12	75	4
YUSE-4S11010	11.1	27	12	75	4
YUSE-4S11020	11.2	27	12	75	4

YESE

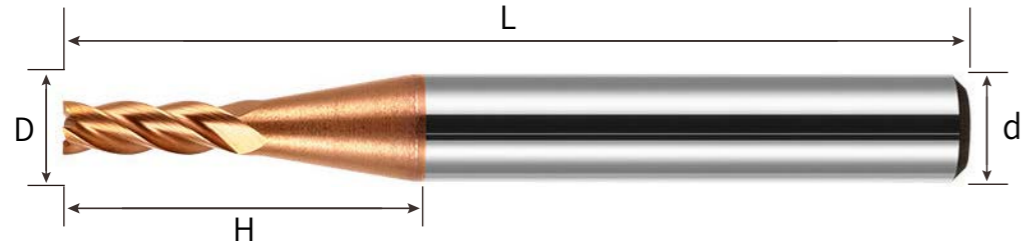

型号	刃径	刃长	柄径	总长	刃数
Code No.	D	H	d	L	T
YUSE-4S11030	11.3	28	12	75	4
YUSE-4S11040	11.4	28	12	75	4
YUSE-4S11050	11.5	28	12	75	4
YUSE-4S11060	11.6	29	12	75	4
YUSE-4S11070	11.7	29	12	75	4
YUSE-4S11080	11.8	29	12	75	4
YUSE-4S11090	11.9	30	12	75	4
YUSE-4S13000	13	45	14	100	4
YUSE-4S15000	15	45	16	100	4

YUSE

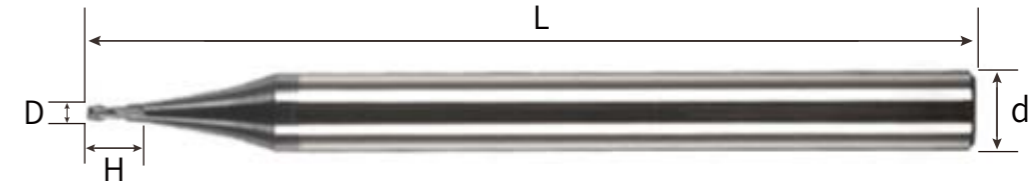

型号	刃径	刃长	柄径	总长	刃数
Code No.	D	H	d	L	T
YUSE-2S001	0.1	0.2	4	50	2
YUSE-2S002	0.2	0.4	4	50	2
YUSE-2S003	0.3	0.6	4	50	2
YUSE-2S004	0.4	0.8	4	50	2
YUSE-2S005	0.5	1	4	50	2
YUSE-2S006	0.6	1.2	4	50	2
YUSE-2S007	0.7	1.4	4	50	2
YUSE-2S008	0.8	1.6	4	50	2
YUSE-2S009	0.9	1.8	4	50	2

可切削材料适用表 Applicable table for cutting materials

非常合适 合适

碳素钢 carbon steel	合金钢 Alloy steel	预硬钢、淬硬钢 Prehardened steel, hardened steel				不锈钢 Stainless steel	铸铁 cast iron 球墨铸铁 Spheroidal graphite cast iron	铜合金 Copper alloy	铝合金 Aluminium alloy	钛合金 titanium alloy	耐热合金 Heat-resisting alloy
		~40HRC	~50HRC	~55HRC	~68HRC						
○	○	○	○	○	○	○	○	○	○	○	

Delivery 交货期 请咨询 Please ask Order 订货范例 Code No. YUSE-4S0105

可切削材料适用表 Applicable table for cutting materials

非常合适 合适

碳素钢 carbon steel	合金钢 Alloy steel	预硬钢、淬硬钢 Prehardened steel, hardened steel				不锈钢 Stainless steel	铸铁 cast iron 球墨铸铁 Spheroidal graphite cast iron	铜合金 Copper alloy	铝合金 Aluminium alloy	钛合金 titanium alloy	耐热合金 Heat-resisting alloy
		~40HRC	~50HRC	~55HRC	~68HRC						
○	○	○	○	○	○	○	○	○	○	○	

Delivery 交货期 请咨询 Please ask Order 订货范例 Code No. YUSE-2S001

YUSE

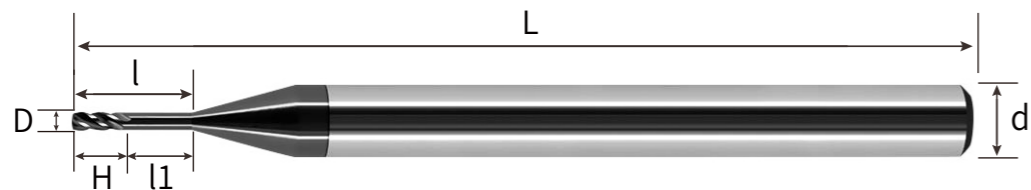

型号 Code No.	刃径 D	深沟长度 l	有效刃长 H	避空长度 l1	柄径 d	总长 L	刃数 T
YUSE-2SL003020	0.3	2	0.6	1.4	4	50	2
YUSE-2SL003030	0.3	3	0.6	2.4	4	50	2
YUSE-2SL003040	0.3	4	0.6	3.4	4	50	2
YUSE-2SL004020	0.4	2	0.8	1.2	4	50	2
YUSE-2SL004030	0.4	3	0.8	2.2	4	50	2
YUSE-2SL004040	0.4	4	0.8	3.2	4	50	2
YUSE-2SL004050	0.4	5	0.8	4.2	4	50	2
YUSE-2SL004060	0.4	6	0.8	5.2	4	50	2
YUSE-2SL005020	0.5	2	1	1	4	50	2
YUSE-2SL005030	0.5	3	1	2	4	50	2
YUSE-2SL005040	0.5	4	1	3	4	50	2
YUSE-2SL005060	0.5	6	1	5	4	50	2
YUSE-2SL005080	0.5	8	1	7	4	50	2
YUSE-2SL005100	0.5	10	1	9	4	50	2
YUSE-2SL006020	0.6	2	1.2	0.8	4	50	2
YUSE-2SL006030	0.6	3	1.2	1.8	4	50	2
YUSE-2SL006040	0.6	4	1.2	2.8	4	50	2
YUSE-2SL006060	0.6	6	1.2	4.8	4	50	2
YUSE-2SL006080	0.6	8	1.2	6.8	4	50	2
YUSE-2SL007030	0.7	3	1.4	1.6	4	50	2
YUSE-2SL007040	0.7	4	1.4	2.6	4	50	2
YUSE-2SL007060	0.7	6	1.4	4.6	4	50	2
YUSE-2SL007080	0.7	8	1.4	6.6	4	50	2
YUSE-2SL007100	0.7	10	1.4	8.6	4	50	2
YUSE-2SL008030	0.8	3	1.6	1.4	4	50	2
YUSE-2SL008040	0.8	4	1.6	2.4	4	50	2
YUSE-2SL008060	0.8	6	1.6	4.4	4	50	2
YUSE-2SL008080	0.8	8	1.6	6.4	4	50	2
YUSE-2SL008100	0.8	10	1.6	8.4	4	50	2
YUSE-2SL009030	0.9	3	1.8	1.2	4	50	2

YUSE

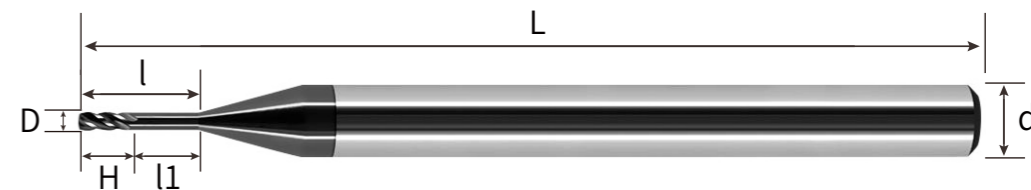

型号 Code No.	刃径 D	深沟长度 l	有效刃长 H	避空长度 l1	柄径 d	总长 L	刃数 T
YUSE-2SL009040	0.9	4	1.8	2.2	4	50	2
YUSE-2SL009060	0.9	6	1.8	4.2	4	50	2
YUSE-2SL009080	0.9	8	1.8	6.2	4	50	2
YUSE-2SL009100	0.9	10	1.8	8.2	4	50	2

可切削材料适用表 Applicable table for cutting materials

○ 非常合适 ○ 合适

碳素钢 carbon steel	合金钢 Alloy steel	预硬钢、淬硬钢 Prehardened steel, hardened steel				不锈钢 Stainless steel	铸铁 cast iron 球墨铸铁 Spheroidal graphite cast iron	铜合金 Copper alloy	铝合金 Aluminium alloy	钛合金 titanium alloy	耐热合金 Heat-resisting alloy
		~40HRC	~50HRC	~55HRC	~68HRC						
○	○	○	○	○		○	○	○		○	○



Delivery  
交货期



请咨询  
Please ask



Order  
订货范例

Code No.  
YUSE-2SL003020



YEAP

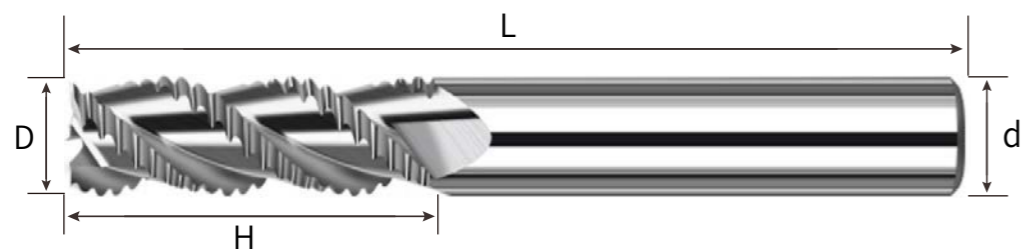

型号 Code No.	刃径 D	刃长 H	柄径 d	总长 L	刃数 T
YEAP-3S010	4	12	4	50	3
YEAP-3L040	4	20	4	75	3
YEAP-3XL040	4	25	4	100	3
YEAP-3S050	5	15	5	50	3
YEAP-3L050	5	20	5	75	3
YEAP-3S0506	5	15	6	50	3
YEAP-3L0506	5	15	6	75	3
YEAP-3S060	6	18	6	50	3
YEAP-3L060	6	25	6	75	3
YEAP-3XL060	6	30	6	100	3
YEAP-3SN080	8	15	8	50	3
YEAP-3S080	8	24	8	60	3
YEAP-3L080	8	30	8	75	3
YEAP-3XL080	8	40	8	100	3
YEAP-3SN100	10	15	10	50	3
YEAP-3S100	10	30	10	75	3
YEAP-3L100	10	40	10	100	3
YEAP-3XL100	10	50	10	150	3
YEAP-3SN120	12	15	12	50	3
YEAP-3S120	12	36	12	75	3
YEAP-3L120	12	45	12	100	3
YEAP-3XL120	12	60	12	150	3
YEAP-3S140	14	40	14	100	3
YEAP-3L140	14	50	14	150	3
YEAP-3SN160	16	15	16	50	3
YEAP-3S160	16	48	16	100	3
YEAP-3XL160	16	65	16	150	3
YEAP-3XLL160	16	65	16	200	3
YEAP-3S180	18	50	18	100	3
YEAP-3L180	18	60	18	150	3

YEAP

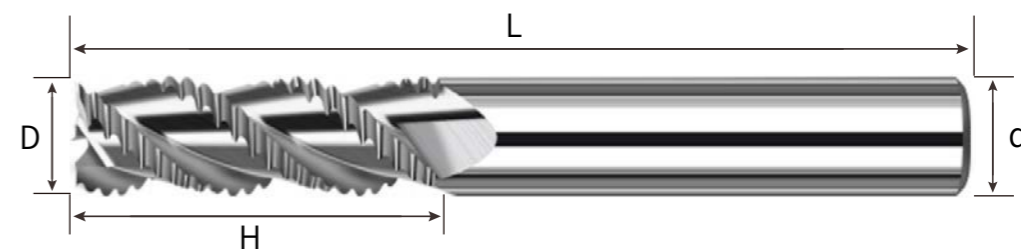

型号 Code No.	刃径 D	刃长 H	柄径 d	总长 L	刃数 T
YEAP-3S200	20	45	20	100	3
YEAP-3XL200	20	65	20	150	3
YEAP-3XLL200	20	80	20	200	3

可切削材料适用表 Applicable table for cutting materials

非常合适 合适

碳素钢 carbon steel	合金钢 Alloy steel	预硬钢、淬硬钢 Prehardened steel, hardened steel				不锈钢 Stainless steel	铸铁 cast iron 球墨铸铁 Spheroidal graphite cast iron	铜合金 Copper alloy	铝合金 Aluminium alloy	钛合金 titanium alloy	耐热合金 Heat-resisting alloy
		~40HRC	~50HRC	~55HRC	~68HRC						
								○	○		



Delivery  
交货期



请咨询  
Please ask



Order  
订货范例

Code No.  
YEAP-3S010

## YUSE

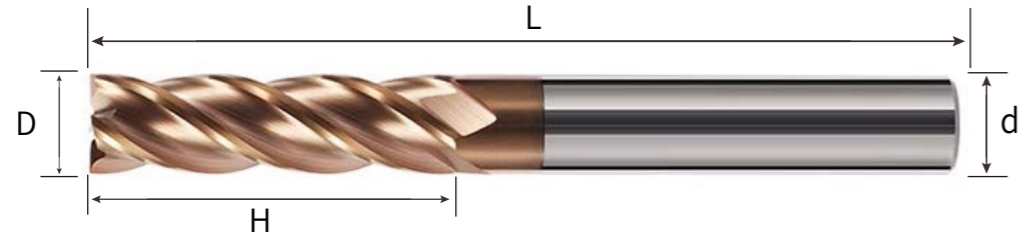

型号	刃径	刃长	柄径	总长	刃数
Code No.	D	H	d	L	T
YUSE-4S010	1	2.5	4	50	4
YUSE-4SL010	1	3	4	50	4
YUSE-4S015	1.5	4	4	50	4
YUSE-4SL015	1.5	4.5	4	50	4
YUSE-4S020	2	5	4	50	4
YUSE-4SL020	2	6	4	50	4
YUSE-4S025	2.5	6.5	4	50	4
YUSE-4SL025	2.5	7.5	4	50	4
YUSE-4S030	3	8	4	50	4
YUSE-4SL030	3	9	4	50	4
YUSE-4S035	3.5	9	4	50	4
YUSE-4SL035	3.5	10.5	4	50	4
YUSE-4S040	4	10	4	50	4
YUSE-4SL040	4	12	4	50	4
YUSE-4S050	5	13	6	50	4
YUSE-4SL050	5	15	6	50	4
YUSE-4S060	6	15	6	50	4
YUSE-4SL060	6	18	6	60	4
YUSE-4S070	7	18	8	60	4
YUSE-4S080	8	20	8	60	4
YUSE-4SL080	8	24	8	60	4
YUSE-4S090	9	23	10	75	4
YUSE-4S100	10	25	10	75	4
YUSE-4SL100	10	30	10	75	4
YUSE-4S120	12	30	12	75	4
YUSE-4SL120	12	36	12	75	4
YUSE-4S140	14	40	14	100	4
YUSE-4S160	16	45	16	100	4
YUSE-4L020	2	7	4	75	4
YUSE-4XL020	2	9	4	100	4

## YUSE

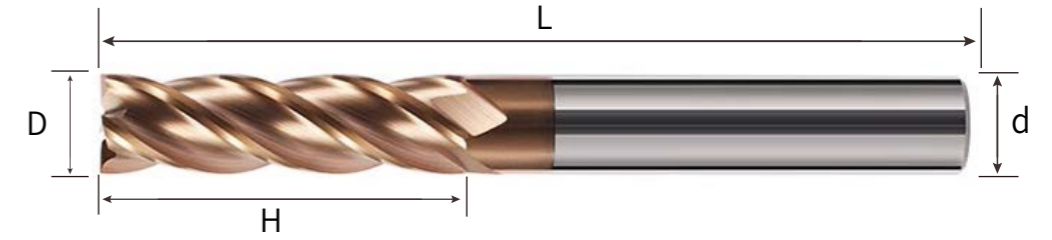

型号	刃径	刃长	柄径	总长	刃数
Code No.	D	H	d	L	T
YUSE-4L030	3	10	4	75	4
YUSE-4XL030	3	15	4	100	4
YUSE-4L040	4	15	4	75	4
YUSE-4XL040	4	18	4	100	4
YUSE-4L060	6	20	6	75	4
YUSE-4XL060	6	25	6	100	4
YUSE-4L080	8	25	8	75	4
YUSE-4XL080	8	30	8	100	4
YUSE-4L100	10	40	10	100	4
YUSE-4LSL100	10	45	10	100	4
YUSE-4LSL100L	10	50	10	100	4
YUSE-4XL100	10	50	10	150	4
YUSE-4XL100L	10	60	10	150	4
YUSE-4L120	12	40	12	100	4
YUSE-4LSL120	12	45	12	100	4
YUSE-4LSL120L	12	50	12	100	4
YUSE-4XL120	12	50	12	150	4
YUSE-4XL120L	12	60	12	150	4
YUSE-4L160	16	70	16	150	4

## 可切削材料适用表 Applicable table for cutting materials

 非常合适  合适

碳素钢 carbon steel	合金钢 Alloy steel	预硬钢、淬硬钢 Prehardened steel, hardened steel				不锈钢 Stainless steel	铸铁 cast iron 球墨铸铁 Spheroidal graphite cast iron	铜合金 Copper alloy	铝合金 Aluminium alloy	钛合金 titanium alloy	耐热合金 Heat-resisting alloy
		~40HRC	~50HRC	~55HRC	~68HRC						
<input checked="" type="radio"/>	<input checked="" type="radio"/>	<input checked="" type="radio"/>	<input checked="" type="radio"/>	<input checked="" type="radio"/>	<input type="radio"/>	<input type="radio"/>	<input type="radio"/>	<input type="radio"/>	<input type="radio"/>	<input type="radio"/>	

Delivery  
交货期请咨询  
Please askOrder  
订货范例Code No.  
YUSE-4S010

YEAB

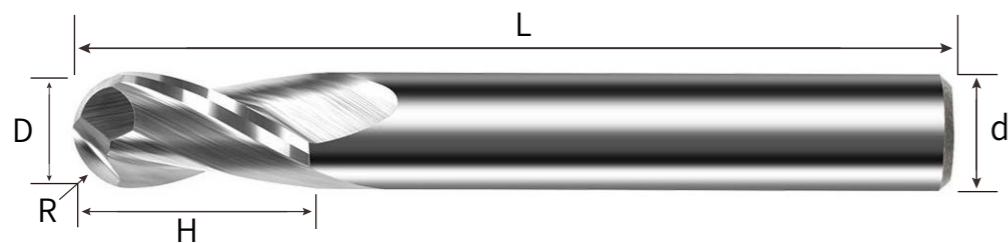

型号	刃径	R角半径	刃长	柄径	总长	刃数
Code No.	D	R	H	d	H	T
YEAB-2S010R05	1	0.5	1.8	4	50	2
YEAB-2S012R06	1.2	0.6	2	4	50	2
YEAB-2S014R07	1.4	0.7	2.5	4	50	2
YEAB-2S016R08	1.6	0.8	3	4	50	2
YEAB-2S018R09	1.8	0.9	3.5	4	50	2
YEAB-2S020R1	2	1	4	4	50	2
YEAB-2S025R125	2.5	1.25	5	4	50	2
YEAB-2S030R15	3	1.5	6	4	50	2
YEAB-2S035R175	3.5	1.75	6	4	50	2
YEAB-2S040R2	4	2	8	4	50	2
YEAB-2L040R2	4	2	8	4	75	2
YEAB-2XL040R2	4	2	8	4	100	2
YEAB-2S050R25	5	2.5	10	6	50	2
YEAB-2L050R25	5	2.5	10	6	75	2
YEAB-2XL050R25	5	2.5	10	6	100	2
YEAB-2S060R3	6	3	12	6	50	2
YEAB-2L060R3	6	3	15	6	75	2
YEAB-2XL060R3	6	3	15	6	100	2
YEAB-2S070R35	7	3.5	15	8	60	2
YEAB-2L070R35	7	3.5	15	8	75	2
YEAB-2XL070R35	7	3.5	15	8	100	2
YEAB-2S080R4	8	4	16	8	60	2
YEAB-2L080R4	8	4	16	8	75	2
YEAB-2XL080R4	8	4	20	8	100	2
YEAB-2S100R5	10	5	20	10	75	2
YEAB-2L100R5	10	5	20	10	100	2
YEAB-2XL100R5	10	5	20	10	150	2
YEAB-2S1200R6	12	6	24	12	75	2
YEAB-2L120R6	12	6	24	12	100	2
YEAB-2S160R8	16	8	32	16	100	2

YEAB

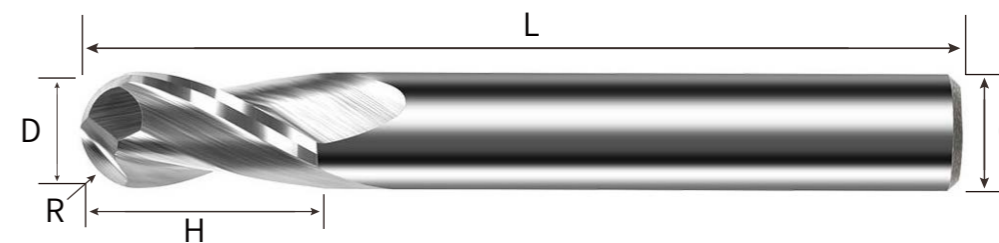

型号	刃径	R角半径	刃长	柄径	总长	刃数
Code No.	D	R	H	d	H	T
YEAB-2L160R8	16	8	32	16	150	2
YEAB-2S200R10	20	10	40	20	100	2
YEAB-2L200R10	20	10	40	20	150	2

可切削材料适用表 Applicable table for cutting materials ○ 非常合适 ○ 合适

碳素钢 carbon steel	合金钢 Alloy steel	预硬钢、淬硬钢 Prehardened steel, hardened steel				不锈钢 Stainless steel	铸铁 cast iron 球墨铸铁 Spheroidal graphite cast iron	铜合金 Copper alloy	铝合金 Aluminium alloy	钛合金 titanium alloy	耐热合金 Heat-resisting alloy
		~40HRC	~50HRC	~55HRC	~68HRC						
						○	○	○			



Delivery  
交货期



请咨询  
Please ask



Order  
订货范例

Code No.  
YEAB-2S010R05

YEAKR

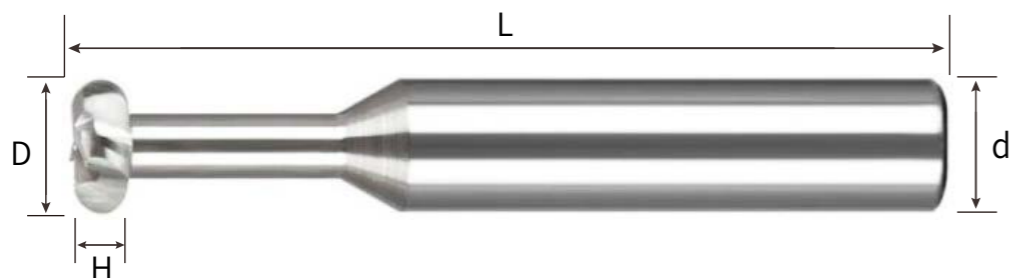

型号 Code No.	刃径 D	R角半径 R	刃宽 H	柄径 d	总长 L	刃数 T
YEAKR-4S04002505	4	0.25	0.5	4	50	4
YEAKR-4S04005010	4	0.5	1	4	50	4
YEAKR-4S04007515	4	0.75	1.5	4	50	4
YEAKR-4S04010020	4	1	2	4	50	4
YEAKR-4S04015030	4	1.5	3	4	50	4
YEAKR-4S04020040	4	2	4	4	50	4
YEAKR-4S04025050	4	2.5	5	4	50	4
YEAKR-4S06005010	6	0.5	1	6	50	4
YEAKR-4S06007515	6	0.75	1.5	6	50	4
YEAKR-4S06010020	6	2	4	6	50	4
YEAKR-4S06015030	6	1.5	3	6	50	4
YEAKR-4S06020040	6	2	4	6	50	4
YEAKR-4S06025050	6	2.5	5	6	50	4
YEAKR-4S08005010	8	0.5	1	8	60	4
YEAKR-4S08007515	8	0.75	1.5	8	60	4
YEAKR-4S08010020	8	2	4	8	60	4
YEAKR-4S08015030	8	1.5	3	8	60	4
YEAKR-4S08020040	8	2	4	8	60	4
YEAKR-4S08025050	8	2.5	5	8	60	4
YEAKR-4S10005010	10	0.5	1	10	60	4
YEAKR-4S10007515	10	0.75	1.5	10	60	4
YEAKR-4S10010020	10	1	2	10	60	4
YEAKR-4S10015030	10	1.5	3	10	60	4
YEAKR-4S10020040	10	2	4	10	60	4

YEAKR

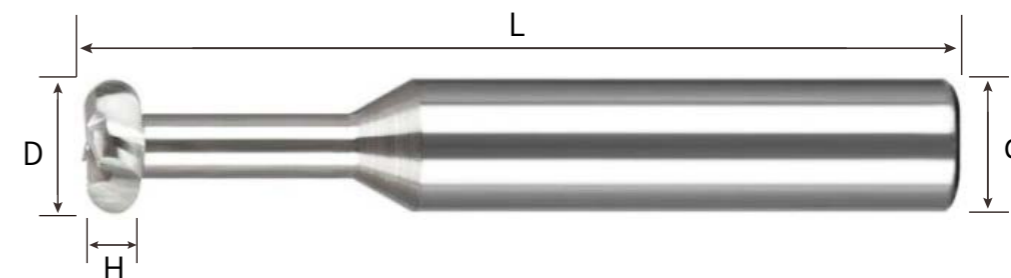

型号 Code No.	刃径 D	R角半径 R	刃宽 H	柄径 d	总长 L	刃数 T
YEAKR-4S10030060	10	3	6	10	60	4
YEAKR-4S12005010	12	0.5	1	12	60	4
YEAKR-4S12007515	12	0.75	1.5	12	60	4
YEAKR-4S12010020	12	1	2	12	60	4
YEAKR-4S12015030	12	1.5	3	12	60	4
YEAKR-4S12020040	12	2	4	12	60	4
YEAKR-4S12025050	12	2.5	5	12	60	4
YEAKR-4S12030060	12	3	6	12	60	4

可切削材料适用表 Applicable table for cutting materials

非常合适 合适

碳素钢 carbon steel	合金钢 Alloy steel	预硬钢、淬硬钢 Prehardened steel, hardened steel				不锈钢 Stainless steel	铸铁 cast iron 球墨铸铁 Spheroidal graphite cast iron	铜合金 Copper alloy	铝合金 Aluminium alloy	钛合金 titanium alloy	耐热合金 Heat-resisting alloy
		~40HRC	~50HRC	~55HRC	~68HRC						

Delivery 交货期 请咨询 Please ask Order 订货范例 Code No. YEAKR-4S04002505

可切削材料适用表 Applicable table for cutting materials

非常合适 合适

碳素钢 carbon steel	合金钢 Alloy steel	预硬钢、淬硬钢 Prehardened steel, hardened steel				不锈钢 Stainless steel	铸铁 cast iron 球墨铸铁 Spheroidal graphite cast iron	铜合金 Copper alloy	铝合金 Aluminium alloy	钛合金 titanium alloy	耐热合金 Heat-resisting alloy
		~40HRC	~50HRC	~55HRC	~68HRC						

Delivery 交货期 请咨询 Please ask Order 订货范例 Code No. YEAKR-4S04002505

YUSKR



型号 Code No.	刃径 D	R角半径 R	刃宽 H	柄径 d	总长 L	刃数 T
YUSKR-4S04002505	4	0.25	0.5	4	50	4
YUSKR-4S04005010	4	0.5	1	4	50	4
YUSKR-4S04007515	4	0.75	1.5	4	50	4
YUSKR-4S04010020	4	1	2	4	50	4
YUSKR-4S04015030	4	1.5	3	4	50	4
YUSKR-4S04020040	4	2	4	4	50	4
YUSKR-4S04025050	4	2.5	5	4	50	4
YUSKR-4S06005010	6	0.5	1	6	50	4
YUSKR-4S06007515	6	0.75	1.5	6	50	4
YUSKR-4S06010020	6	2	4	6	50	4
YUSKR-4S06015030	6	1.5	3	6	50	4
YUSKR-4S06020040	6	2	4	6	50	4
YUSKR-4S06025050	6	2.5	5	6	50	4
YUSKR-4S08005010	8	0.5	1	8	60	4
YUSKR-4S08007515	8	0.75	1.5	8	60	4
YUSKR-4S08010020	8	2	4	8	60	4
YUSKR-4S08015030	8	1.5	3	8	60	4
YUSKR-4S08020040	8	2	4	8	60	4
YUSKR-4S08025050	8	2.5	5	8	60	4
YUSKR-4S10005010	10	0.5	1	10	60	4
YUSKR-4S10007515	10	0.75	1.5	10	60	4
YUSKR-4S10010020	10	1	2	10	60	4
YUSKR-4S10015030	10	1.5	3	10	60	4
YUSKR-4S10020040	10	2	4	10	60	4

YUSKR



型号 Code No.	刃径 D	R角半径 R	刃宽 H	柄径 d	总长 L	刃数 T
YUSKR-4S10030060	10	3	6	10	60	4
YUSKR-4S12005010	12	0.5	1	12	60	4
YUSKR-4S12007515	12	0.75	1.5	12	60	4
YUSKR-4S12010020	12	1	2	12	60	4
YUSKR-4S12015030	12	1.5	3	12	60	4
YUSKR-4S12020040	12	2	4	12	60	4
YUSKR-4S12025050	12	2.5	5	12	60	4
YUSKR-4S12030060	12	3	6	12	60	4

可切削材料适用表 Applicable table for cutting materials

非常合适 合适

碳素钢 carbon steel	合金钢 Alloy steel	预硬钢、淬硬钢 Prehardened steel, hardened steel				不锈钢 Stainless steel	铸铁 cast iron 球墨铸铁 Spheroidal graphite cast iron	铜合金 Copper alloy	铝合金 Aluminium alloy	钛合金 titanium alloy	耐热合金 Heat-resisting alloy
		~40HRC	~50HRC	~55HRC	~68HRC						
○	○	○	○	○	○	○	○	○	○	○	



Delivery  
交货期



请咨询  
Please ask



Order  
订货范例

Code No.  
YUSKR-4S04002505

可切削材料适用表 Applicable table for cutting materials

非常合适 合适

碳素钢 carbon steel	合金钢 Alloy steel	预硬钢、淬硬钢 Prehardened steel, hardened steel				不锈钢 Stainless steel	铸铁 cast iron 球墨铸铁 Spheroidal graphite cast iron	铜合金 Copper alloy	铝合金 Aluminium alloy	钛合金 titanium alloy	耐热合金 Heat-resisting alloy
		~40HRC	~50HRC	~55HRC	~68HRC						
○	○	○	○	○	○	○	○	○	○	○	



Delivery  
交货期



请咨询  
Please ask



Order  
订货范例

Code No.  
YUSKR-4S04002505

YUSB

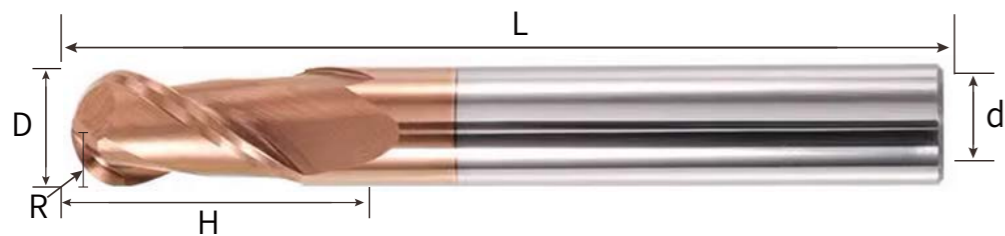

型号	刃径	R角半径	刃长	柄径	总长	刃数
Code No.	D	R	H	d	L	T
YUSB-2S010	1	0.5	1.8	4	50	2
YUSB-2S012	1.2	0.6	2	4	50	2
YUSB-2S014	1.4	0.7	2.5	4	50	2
YUSB-2S016	1.6	0.8	3	4	50	2
YUSB-2S018	1.8	0.9	3.5	4	50	2
YUSB-2S020	2	1	4	4	50	2
YUSB-2S025	2.5	1.25	5	4	50	2
YUSB-2S030	3	1.5	6	4	50	2
YUSB-2S035	3.5	1.75	6	4	50	2
YUSB-2S040	4	2	8	4	50	2
YUSB-2L040	4	2	8	4	75	2
YUSB-2XL040	4	2	8	4	100	2
YUSB-2S050	5	2.5	10	6	50	2
YUSB-2L050	5	2.5	10	5	75	2
YUSB-2XL050	5	2.5	10	5	100	2
YUSB-2S060	6	3	12	5	50	2
YUSB-2L060	6	3	15	5	75	2
YUSB-2XL060	6	3	15	5	100	2
YUSB-2S070	7	3.5	15	8	60	2
YUSB-2L070	7	3.5	15	8	75	2
YUSB-2XL070	7	3.5	15	8	100	2
YUSB-2S080	8	4	16	8	60	2
YUSB-2L080	8	4	16	8	75	2

YUSB

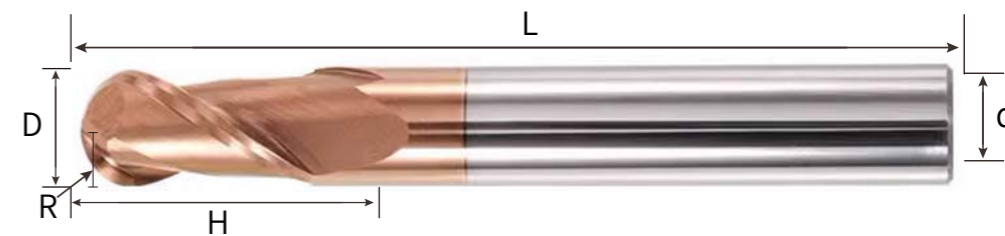

型号	刃径	R角半径	刃长	柄径	总长	刃数
Code No.	D	R	H	d	L	T
YUSB-2XL080	8	4	20	8	100	2
YUSB-2S100	10	5	20	10	75	2
YUSB-2L100	10	5	20	10	100	2
YUSB-2XL100	10	5	30	10	150	2
YUSB-2S120	12	6	24	12	75	2
YUSB-2L120	12	6	24	12	100	2
YUSB-2XL120	12	6	30	12	150	2

可切削材料适用表 Applicable table for cutting materials

○ 非常合适 ○ 合适

碳素钢 carbon steel	合金钢 Alloy steel	预硬钢、淬硬钢 Prehardened steel, hardened steel				不锈钢 Stainless steel	铸铁 cast iron 球墨铸铁 Spheroidal graphite cast iron	铜合金 Copper alloy	铝合金 Aluminium alloy	钛合金 titanium alloy	耐热合金 Heat-resisting alloy
		~40HRC	~50HRC	~55HRC	~68HRC						
○	○	○	○	○	○	○	○		○	○	

Delivery 交货期 请咨询 Please ask Order 订货范例 Code No. YUSB-2S010

可切削材料适用表 Applicable table for cutting materials

○ 非常合适 ○ 合适

碳素钢 carbon steel	合金钢 Alloy steel	预硬钢、淬硬钢 Prehardened steel, hardened steel				不锈钢 Stainless steel	铸铁 cast iron 球墨铸铁 Spheroidal graphite cast iron	铜合金 Copper alloy	铝合金 Aluminium alloy	钛合金 titanium alloy	耐热合金 Heat-resisting alloy
		~40HRC	~50HRC	~55HRC	~68HRC						
○	○	○	○	○	○	○	○		○	○	

Delivery 交货期 请咨询 Please ask Order 订货范例 Code No. YUSB-2S010

YEAR

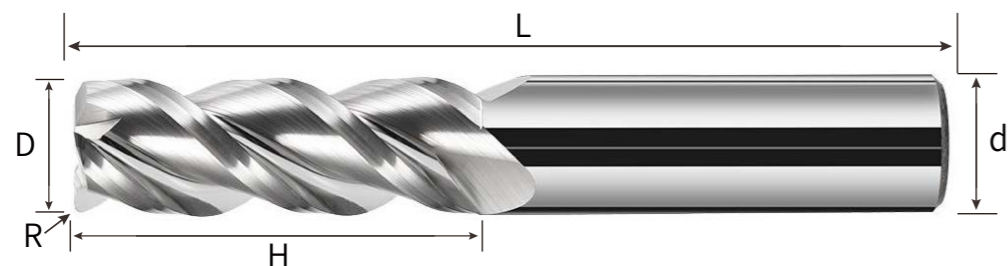

型号	刃径	R角半径	刃长	柄径	总长	刃数
Code No.	D	R	H	d	L	T
YEAR-3S010R02	1	0.2	3	4	50	3
YEAR-3S020R02	2	0.2	5	4	50	3
YEAR-3S020R03	2	0.3	5	4	50	3
YEAR-3S020R05	2	0.5	5	4	50	3
YEAR-3S030R02	3	0.2	8	4	50	3
YEAR-3S030R03	3	0.3	8	4	50	3
YEAR-3S030R05	3	0.5	8	4	50	3
YEAR-3S030R1	3	1	8	4	50	3
YEAR-3S040R02	4	0.2	10	4	50	3
YEAR-3S040R03	4	0.3	10	4	50	3
YEAR-3S040R05	4	0.5	10	4	50	3
YEAR-3S040R1	4	1	10	4	50	3
YEAR-3S040R15	4	1.5	10	4	50	3
YEAR-3L040R05	4	0.5	12	4	75	3
YEAR-3XL040R05	4	0.5	15	4	100	3
YEAR-3S060R02	6	0.2	15	6	50	3
YEAR-3S060R03	6	0.3	15	6	50	3
YEAR-3S060R05	6	0.5	15	6	50	3
YEAR-3S060R1	6	1	15	6	50	3
YEAR-3S060R15	6	1.5	15	6	50	3
YEAR-3S060R2	6	2	15	6	50	3
YEAR-3L060R05	6	0.5	18	6	75	3
YEAR-3XL060R05	6	0.5	20	6	100	3
YEAR-3XLL060R05	6	0.5	30	6	150	3
YEAR-3S080R02	8	0.2	20	8	60	3
YEAR-3S080R03	8	0.3	20	8	60	3
YEAR-3S080R05	8	0.5	20	8	60	3
YEAR-3S080R1	8	1	20	8	60	3
YEAR-3L080R05	8	0.5	24	8	75	3
YEAR-3XL080R05	8	0.5	30	8	100	3

YEAR

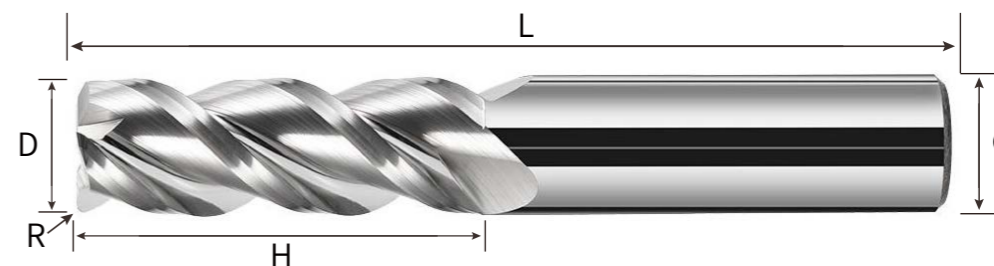

型号	刃径	R角半径	刃长	柄径	总长	刃数
Code No.	D	R	H	d	L	T
YEAR-3S100R05	10	0.5	25	10	75	3
YEAR-3L100R05	10	0.5	30	10	100	3
YEAR-3XL100R05	10	0.5	40	10	150	3
YEAR-3S120R05	12	0.5	30	12	75	3
YEAR-3L120R05	12	0.5	40	12	100	3
YEAR-3XL120R05	12	0.5	50	12	150	3
YEAR-3S160R05	16	0.5	40	16	100	3
YEAR-3L160R05	16	0.5	50	16	150	3
YEAR-3S200R05	20	0.5	40	20	100	3
YEAR-3L200R05	20	0.5	50	20	150	3

可切削材料适用表 Applicable table for cutting materials

非常合适 合适

碳素钢 carbon steel	合金钢 Alloy steel	预硬钢、淬硬钢 Prehardened steel, hardened steel				不锈钢 Stainless steel	铸铁 cast iron 球墨铸铁 Spheroidal graphite cast iron	铜合金 Copper alloy	铝合金 Aluminium alloy	钛合金 titanium alloy	耐热合金 Heat-resisting alloy
		~40HRC	~50HRC	~55HRC	~68HRC						



Delivery  
交货期



请咨询  
Please ask



Order  
订货范例

Code No.  
YEAR-3S010R02

YUSR

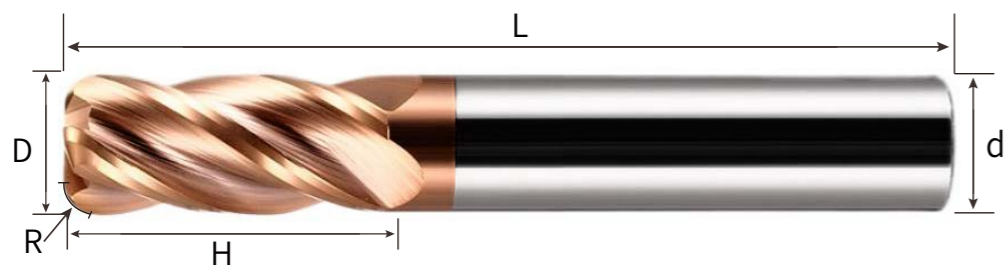

型号 Code No.	刃径 D	R角半径 R	刃长 H	柄径 d	总长 L	刃数 T
YUSR-4S010R02	1	0.2	3	4	50	4
YUSR-4S010R03	1	0.3	3	4	50	4
YUSR-4S015R02	1.5	0.2	4	4	50	4
YUSR-4S015R03	1.5	0.3	4	4	50	4
YUSR-4S020R02	2	0.2	5	4	50	4
YUSR-4S020R03	2	0.3	5	4	50	4
YUSR-4S020R05	2	0.5	5	4	50	4
YUSR-4S025R02	2.5	0.2	7	4	50	4
YUSR-4S025R03	2.5	0.3	7	4	50	4
YUSR-4S025R05	2.5	0.5	7	4	50	4
YUSR-4S030R02	3	0.2	8	4	50	4
YUSR-4S030R03	3	0.3	8	4	50	4
YUSR-4S030R05	3	0.5	8	4	50	4
YUSR-4S030R1	3	1	8	4	50	4
YUSR-4S040R02	4	0.2	10	4	50	4
YUSR-4S040R03	4	0.3	10	4	50	4
YUSR-4S040R05	4	0.5	10	4	50	4
YUSR-4S040R1	4	1	10	4	50	4
YUSR-4S040R15	4	1.5	10	4	50	4
YUSR-4S050R02	5	0.2	13	6	50	4
YUSR-4S050R03	5	0.3	13	6	50	4
YUSR-4S050R05	5	0.5	13	6	50	4
YUSR-4S050R1	5	1	13	6	50	4
YUSR-4S050R15	5	1.5	13	6	50	4
YUSR-4S060R02	6	0.2	15	6	50	4
YUSR-4S060R03	6	0.3	15	6	50	4
YUSR-4S060R05	6	0.5	15	6	50	4
YUSR-4S060R1	6	1	15	6	50	4
YUSR-4S060R15	6	1.5	15	6	50	4
YUSR-4S060R2	6	2	15	6	50	4
YUSR-4L060R05	6	0.5	18	6	75	4
YUSR-4L060R1	6	1	18	6	75	4

YUSR

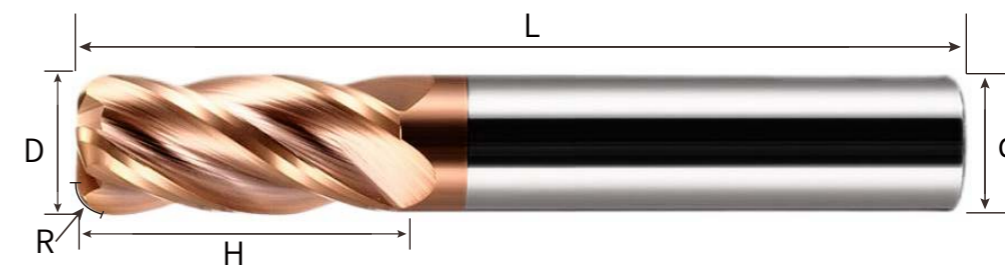

型号 Code No.	刃径 D	R角半径 R	刃长 H	柄径 d	总长 L	刃数 T
YUSR-4S080R03	8	0.3	20	8	60	4
YUSR-4S080R05	8	0.5	20	8	60	4
YUSR-4S080R1	8	1	20	8	60	4
YUSR-4S080R15	8	1.5	20	8	60	4
YUSR-4S080R2	8	2	20	8	60	4
YUSR-4L080R05	8	0.5	24	8	75	4
YUSR-4L080R1	8	1	24	8	75	4
YUSR-4L080R15	8	1.5	24	8	75	4
YUSR-4L080R2	8	2	24	8	75	4
YUSR-4S100R5	10	0.5	25	10	75	4
YUSR-4S100R1	10	1	25	10	75	4
YUSR-4S100R15	10	1.5	25	10	75	4
YUSR-4S100R2	10	2	25	10	75	4
YUSR-4L100R05	10	0.5	30	10	100	4
YUSR-4L100R1	10	1	30	10	100	4
YUSR-4L100R15	10	1.5	30	10	100	4
YUSR-4L100R2	10	2	30	10	100	4
YUSR-4S120R05	12	0.5	30	12	75	4
YUSR-4S120R1	12	1	30	12	75	4
YUSR-4S120R15	12	1.5	30	12	75	4
YUSR-4S120R2	12	2	30	12	75	4
YUSR-4L120R05	12	0.5	40	12	100	4
YUSR-4L120R1	12	1	40	12	100	4
YUSR-4L120R15	12	1.5	40	12	100	4
YUSR-4L120R2	12	2	40	12	100	4

可切削材料适用表 Applicable table for cutting materials ○ 非常合适 ○ 合适

碳素钢 carbon steel	合金钢 Alloy steel	预硬钢、淬硬钢 Prehardened steel, hardened steel				不锈钢 Stainless steel	铸铁 cast iron 球墨铸铁 Spheroidal graphite cast iron	铜合金 Copper alloy	铝合金 Aluminium alloy	钛合金 titanium alloy	耐热合金 Heat-resisting alloy
		~40HRC	~50HRC	~55HRC	~68HRC						
○	○	○	○	○	○	○	○	○	○	○	

Delivery 交货期
 请咨询 Please ask
 Order 订货范例
Code No. **YUSR-4S010R02**



YUSK

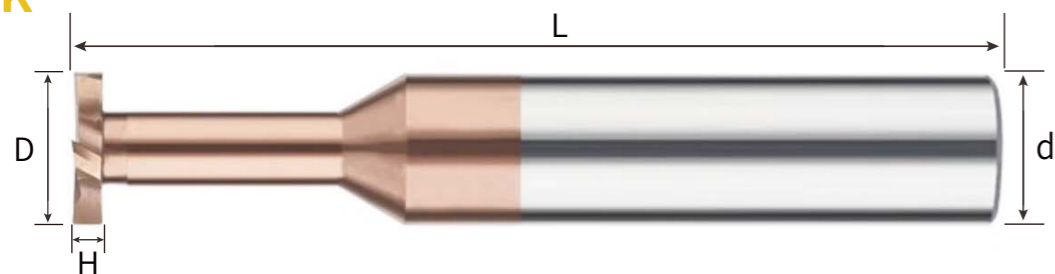

刃径	刃宽											柄径	总长	刃数			
D	H											d	L	T			
2	0.5	0.6	0.7	0.8	0.9	1	1.1	1.2	1.3	1.5	1.6	1.7	4	50	4		
	1.8	1.9	2														
3	0.5	0.6	0.7	0.8	0.9	1	1.1	1.2	1.3	1.5	1.6	1.7					
	1.8	1.9	2	2.1	2.2	2.3	2.5	2.6	2.7	2.8	2.9	3					
4	0.5	0.6	0.7	0.8	0.9	1	1.1	1.2	1.3	1.5	1.6	1.7					
	1.8	1.9	2	2.1	2.2	2.3	2.5	2.6	2.7	2.8	2.9	3					
	3.1	3.2	3.3	3.5	3.6	3.7	3.8	3.9	4	4.5	5						
6	0.5	0.6	0.7	0.8	0.9	1	1.1	1.2	1.3	1.5	1.6	1.7					
	1.8	1.9	2	2.1	2.2	2.3	2.5	2.6	2.7	2.8	2.9	3					
	3.1	3.2	3.3	3.5	3.6	3.7	3.8	3.9	4	4.5	5	6					
8	0.5	0.6	0.7	0.8	0.9	1	1.1	1.2	1.3	1.5	1.6	1.7				8	60
	1.8	1.9	2	2.1	2.2	2.3	2.5	2.6	2.7	2.8	2.9	3					
	3.1	3.2	3.3	3.5	3.6	3.7	3.8	3.9	4	4.5	5	6					
	8																
10	0.5	0.6	0.7	0.8	0.9	1	1.1	1.2	1.3	1.5	1.6	1.7	10				
	1.8	1.9	2	2.1	2.2	2.3	2.5	2.6	2.7	2.8	2.9	3					
	3.1	3.2	3.3	3.5	3.6	3.7	3.8	3.9	4	4.5	5	5.5					
	6	7	7.5	8	10												
12	0.5	0.6	0.7	0.8	0.9	1	1.1	1.2	1.3	1.5	1.6	1.7	12				
	1.8	1.9	2	2.1	2.2	2.3	2.5	2.6	2.7	2.8	2.9	3					
	3.1	3.2	3.3	3.5	3.6	3.7	3.8	3.9	4	4.5	5	5.5					
	6	6.5	7	7.5	8	10	12										

YUSY

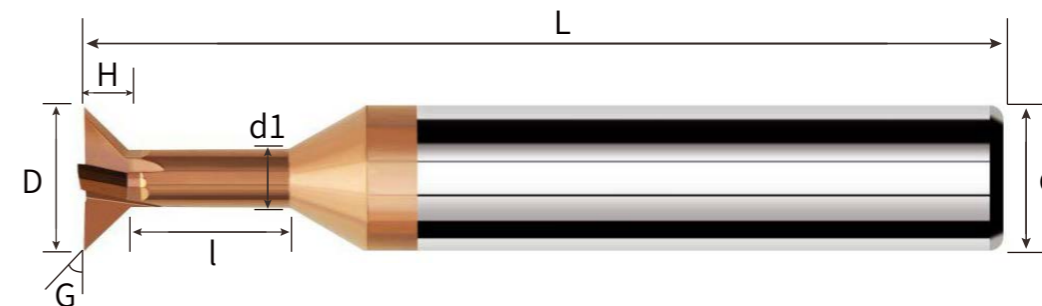

型号	刃径	角度	刃宽	侧径	侧径长度	柄径	总长	刃数
Code No.	D	G	H	d1	l	d	L	T
YUSY-4S020G60	2	60	0.32	0.9	4	4	50	4
YUSY-4S030G60	3	60	0.47	1.4	6	4	50	4
YUSY-4S040G60	4	60	0.62	1.9	8	4	50	4
YUSY-4S050G60	5	60	0.79	2.3	10	6	50	4
YUSY-4S060G60	6	60	0.94	2.8	10	6	50	4
YUSY-4S080G60	8	60	1.29	3.6	12	8	60	4
YUSY-4S100G60	10	60	1.61	4.5	15	10	60	4
YUSY-4S120G60	12	60	1.94	5.4	18	12	60	4
YUSY-4S020G45	2	45	0.55	0.9	4	4	50	4
YUSY-4S030G45	3	45	0.8	1.4	6	4	50	4
YUSY-4S040G45	4	45	1.05	1.9	8	4	50	4
YUSY-4S050G45	5	45	1.35	2.3	10	6	50	4
YUSY-4S060G45	6	45	1.6	2.8	10	6	50	4
YUSY-4S080G45	8	45	2.2	3.6	12	8	60	4
YUSY-4S100G45	10	45	2.75	4.5	15	10	60	4
YUSY-4S120G45	12	45	3.3	5.4	18	12	60	4
YUSY-4S020G30	2	30	0.96	0.9	4	4	50	4
YUSY-4S030G30	3	30	1.4	1.4	6	4	50	4
YUSY-4S040G30	4	30	1.84	1.9	8	4	50	4
YUSY-4S050G30	5	30	2.37	2.3	10	6	50	4
YUSY-4S060G30	6	30	2.81	2.8	10	6	50	4
YUSY-4S080G30	8	30	3.86	3.6	12	8	60	4
YUSY-4S100G30	10	30	4.82	4.5	15	10	60	4
YUSY-4S120G30	12	30	5.79	5.4	18	12	60	4

可切削材料适用表 Applicable table for cutting materials

非常合适 合适

碳素钢 carbon steel	合金钢 Alloy steel	预硬钢、淬硬钢 Prehardened steel, hardened steel				不锈钢 Stainless steel	铸铁 cast iron 球墨铸铁 Spheroidal graphite cast iron	铜合金 Copper alloy	铝合金 Aluminium alloy	钛合金 titanium alloy	耐热合金 Heat-resisting alloy
		~40HRC	~50HRC	~55HRC	~68HRC						
○	○	○	○	○	○	○	○	○	○	○	

Delivery 交货期 请咨询 Please ask Order 订货范例 Code No. YUSK-4S020005

可切削材料适用表 Applicable table for cutting materials

非常合适 合适

碳素钢 carbon steel	合金钢 Alloy steel	预硬钢、淬硬钢 Prehardened steel, hardened steel				不锈钢 Stainless steel	铸铁 cast iron 球墨铸铁 Spheroidal graphite cast iron	铜合金 Copper alloy	铝合金 Aluminium alloy	钛合金 titanium alloy	耐热合金 Heat-resisting alloy
		~40HRC	~50HRC	~55HRC	~68HRC						
○	○	○	○	○	○	○	○	○	○	○	

Delivery 交货期 请咨询 Please ask Order 订货范例 Code No. YUSY-4S020G60

YEAK

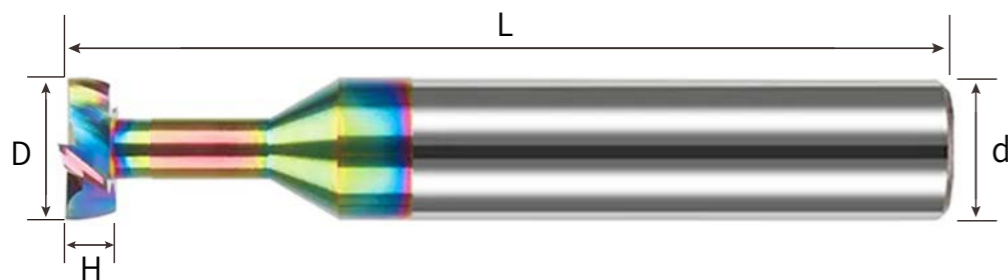

刃径 D	刃宽 H												柄径 d	总长 L	刃数 T
2	0.5	0.6	0.7	0.8	0.9	1	1.1	1.2	1.3	1.4	1.5	1.6	4	50	4
	1.7	1.8	1.9	2											
3	0.5	0.6	0.7	0.8	0.9	1	1.1	1.2	1.3	1.4	1.5	1.6			
	1.7	1.8	1.9	2	2.1	2.2	2.3	2.4	2.5	2.6	2.7	2.8			
	2.9	3													
4	0.5	0.6	0.7	0.8	0.9	1	1.1	1.2	1.3	1.4	1.5	1.6			
	1.7	1.8	1.9	2	2.1	2.2	2.3	2.4	2.5	2.6	2.7	2.8			
	2.9	3	3.1	3.2	3.3	3.4	3.5	3.6	3.7	3.8	3.9	4			
	4.5	5													
6	0.5	0.6	0.7	0.8	0.9	1	1.1	1.2	1.3	1.4	1.5	1.6			
	1.7	1.8	1.9	2	2.1	2.2	2.3	2.4	2.5	2.6	2.7	2.8			
	2.9	3	3.1	3.2	3.3	3.4	3.5	3.6	3.7	3.8	3.9	4			
	4.5	5	6												
8	0.5	0.6	0.7	0.8	0.9	1	1.1	1.2	1.3	1.4	1.5	1.6			
	1.7	1.8	1.9	2	2.1	2.2	2.3	2.4	2.5	2.6	2.7	2.8			
	2.9	3	3.1	3.2	3.3	3.4	3.5	3.6	3.7	3.8	3.9	4			
	4.5	5	6	8											
10	0.5	0.6	0.7	0.8	0.9	1	1.1	1.2	1.3	1.4	1.5	1.6			
	1.7	1.8	1.9	2	2.1	2.2	2.3	2.4	2.5	2.6	2.7	2.8			
	2.9	3	3.1	3.2	3.3	3.4	3.5	3.6	3.7	3.8	3.9	4			
	4.5	5	6.5	7	7.5	8	10								
12	0.5	0.6	0.7	0.8	0.9	1	1.1	1.2	1.3	1.4	1.5	1.6			
	1.7	1.8	1.9	2	2.1	2.2	2.3	2.4	2.5	2.6	2.7	2.8			
	2.9	3	3.1	3.2	3.3	3.4	3.5	3.6	3.7	3.8	3.9	4			
	4.5	5	6.5	7	7.5	8	10	12							

YEAY

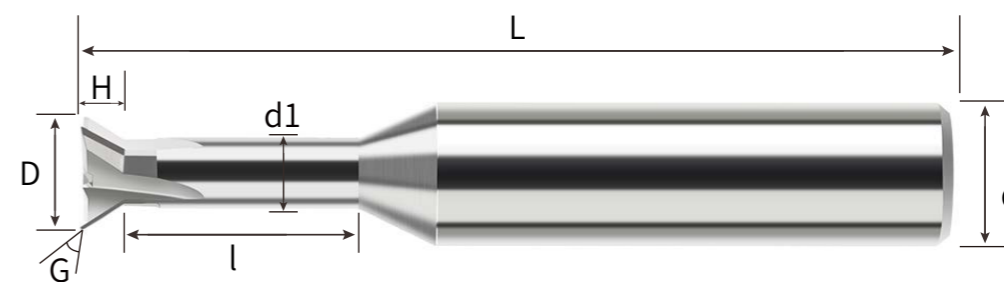

型号 Code No.	刃径 D	角度 G	刃宽 H	侧径 d1	侧径长度 l	柄径 d	总长 L	刃数 T
YEAY-4S020G60	2	60	0.32	0.9	4	4	50	4
YEAY-4S030G60	3	60	0.47	1.4	6	4	50	4
YEAY-4S040G60	4	60	0.62	1.9	8	4	50	4
YEAY-4S050G60	5	60	0.79	2.3	10	6	50	4
YEAY-4S060G60	6	60	0.94	2.8	10	6	50	4
YEAY-4S080G60	8	60	1.29	3.6	12	8	60	4
YEAY-4S100G60	10	60	1.61	4.5	15	10	60	4
YEAY-4S120G60	12	60	1.94	5.4	18	12	60	4
YEAY-4S020G45	2	45	0.55	0.9	4	4	50	4
YEAY-4S030G45	3	45	0.8	1.4	6	4	50	4
YEAY-4S040G45	4	45	1.05	1.9	8	4	50	4
YEAY-4S050G45	5	45	1.35	2.3	10	6	50	4
YEAY-4S060G45	6	45	1.6	2.8	10	6	50	4
YEAY-4S080G45	8	45	2.2	3.6	12	8	60	4
YEAY-4S100G45	10	45	2.75	4.5	15	10	60	4
YEAY-4S120G45	12	45	3.3	5.4	18	12	60	4
YEAY-4S020G30	2	30	0.96	0.9	4	4	50	4
YEAY-4S030G30	3	30	1.4	1.4	6	4	50	4
YEAY-4S040G30	4	30	1.84	1.9	8	4	50	4
YEAY-4S050G30	5	30	2.37	2.3	10	6	50	4
YEAY-4S060G30	6	30	2.81	2.8	10	6	50	4
YEAY-4S080G30	8	30	3.86	3.6	12	8	60	4
YEAY-4S100G30	10	30	4.82	4.5	15	10	60	4
YEAY-4S120G30	12	30	5.79	5.4	18	12	60	4

可切削材料适用表 Applicable table for cutting materials

非常合适 合适

碳素钢 carbon steel	合金钢 Alloy steel	预硬钢、淬硬钢 Prehardened steel, hardened steel				不锈钢 Stainless steel	铸铁 cast iron 球墨铸铁 Spheroidal graphite cast iron	铜合金 Copper alloy	铝合金 Aluminium alloy	钛合金 titanium alloy	耐热合金 Heat-resisting alloy
		~40HRC	~50HRC	~55HRC	~68HRC						

Delivery 交货期 请咨询 Please ask Order 订货范例 Code No. YEAK-4S02005

可切削材料适用表 Applicable table for cutting materials

非常合适 合适

碳素钢 carbon steel	合金钢 Alloy steel	预硬钢、淬硬钢 Prehardened steel, hardened steel				不锈钢 Stainless steel	铸铁 cast iron 球墨铸铁 Spheroidal graphite cast iron	铜合金 Copper alloy	铝合金 Aluminium alloy	钛合金 titanium alloy	耐热合金 Heat-resisting alloy
		~40HRC	~50HRC	~55HRC	~68HRC						

Delivery 交货期 请咨询 Please ask Order 订货范例 Code No. YEAY-4S020G60

YUSB

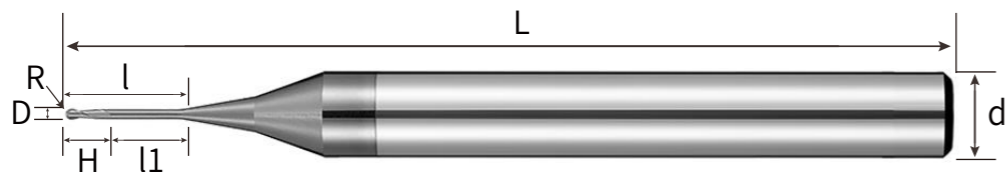

型号	刃径	R角半径	深沟长度	有效刃长	避空长度	柄径	总长	刃数
Code No.	D	R	l	H	l1	d	L	T
YUSB-2SL003020	0.3	0.15	2	0.6	1.4	4	50	2
YUSB-2SL003030	0.3	0.15	3	0.6	2.4	4	50	2
YUSB-2SL003040	0.3	0.15	4	0.6	3.4	4	50	2
YUSB-2SL004020	0.4	0.2	2	0.8	1.2	4	50	2
YUSB-2SL004030	0.4	0.2	3	0.8	2.2	4	50	2
YUSB-2SL004040	0.4	0.2	4	0.8	3.2	4	50	2
YUSB-2SL004050	0.4	0.2	5	0.8	4.2	4	50	2
YUSB-2SL004060	0.4	0.2	6	0.8	5.2	4	50	2
YUSB-2SL005020	0.5	0.25	2	1	1	4	50	2
YUSB-2SL005030	0.5	0.25	3	1	2	4	50	2
YUSB-2SL005040	0.5	0.25	4	1	3	4	50	2
YUSB-2SL005060	0.5	0.25	6	1	5	4	50	2
YUSB-2SL005080	0.5	0.25	8	1	7	4	50	2
YUSB-2SL005100	0.5	0.25	10	1	9	4	50	2
YUSB-2SL006020	0.6	0.3	2	1.2	0.8	4	50	2
YUSB-2SL006030	0.6	0.3	3	1.2	1.8	4	50	2
YUSB-2SL006040	0.6	0.3	4	1.2	2.8	4	50	2
YUSB-2SL006060	0.6	0.3	6	1.2	4.8	4	50	2
YUSB-2SL006080	0.6	0.3	8	1.2	6.8	4	50	2
YUSB-2SL007030	0.7	0.35	3	1.4	1.6	4	50	2
YUSB-2SL007040	0.7	0.35	4	1.4	2.6	4	50	2
YUSB-2SL007060	0.7	0.35	6	1.4	4.6	4	50	2
YUSB-2SL007080	0.7	0.35	8	1.4	6.6	4	50	2
YUSB-2SL007100	0.7	0.35	10	1.4	8.6	4	50	2
YUSB-2SL008030	0.8	0.4	3	1.6	1.4	4	50	2
YUSB-2SL008040	0.8	0.4	4	1.6	2.4	4	50	2
YUSB-2SL008060	0.8	0.4	6	1.6	4.4	4	50	2
YUSB-2SL008080	0.8	0.4	8	1.6	6.4	4	50	2
YUSB-2SL008100	0.8	0.4	10	1.6	8.4	4	50	2
YUSB-2SL009030	0.9	0.45	3	1.8	1.2	4	50	2

YUSB

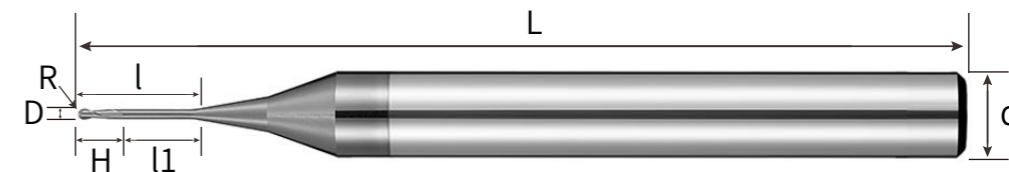

型号	刃径	R角半径	深沟长度	有效刃长	避空长度	柄径	总长	刃数
Code No.	D	R	l	H	l1	d	L	T
YUSB-2SL009040	0.9	0.45	4	1.8	2.2	4	50	2
YUSB-2SL009060	0.9	0.45	6	1.8	4.2	4	50	2
YUSB-2SL009080	0.9	0.45	8	1.8	6.2	4	50	2
YUSB-2SL009100	0.9	0.45	10	1.8	8.2	4	50	2

可切削材料适用表 Applicable table for cutting materials ○ 非常合适 ○ 合适

碳素钢 carbon steel	合金钢 Alloy steel	预硬钢、淬硬钢 Prehardened steel, hardened steel				不锈钢 Stainless steel	铸铁 cast iron 球墨铸铁 Spheroidal graphite cast iron	铜合金 Copper alloy	铝合金 Aluminium alloy	钛合金 titanium alloy	耐热合金 Heat-resisting alloy
		~40HRC	~50HRC	~55HRC	~68HRC						
○	○	○	○	○	○	○	○	○	○	○	

Delivery 交货期
 请咨询 Please ask
 Order 订货范例
Code No. **YUSB-2SL003020**

# YUSB

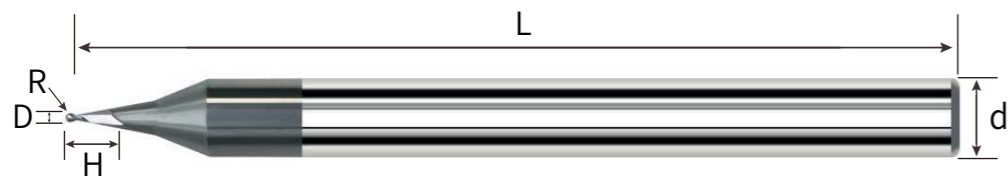

型号	刃径	半径	刃长	柄径	总长	刃数
Code No.	D	R	H	d	L	T
YUSB-2S001	0.1	0.05	0.2	4	50	2
YUSB-2S002	0.2	0.1	0.4	4	50	2
YUSB-2S003	0.3	0.15	0.6	4	50	2
YUSB-2S004	0.4	0.2	0.8	4	50	2
YUSB-2S005	0.5	0.25	1	4	50	2
YUSB-2S006	0.6	0.3	1.2	4	50	2
YUSB-2S007	0.7	0.35	1.4	4	50	2
YUSB-2S008	0.8	0.4	1.6	4	50	2
YUSB-2S009	0.9	0.45	1.8	4	50	2



## 可切削材料适用表 Applicable table for cutting materials

○ 非常合适 ○ 合适

碳素钢 carbon steel	合金钢 Alloy steel	预硬钢、淬硬钢 Prehardened steel, hardened steel				不锈钢 Stainless steel	铸铁 cast iron 球墨铸铁 Spheroidal graphite cast iron	铜合金 Copper alloy	铝合金 Aluminium alloy	钛合金 titanium alloy	耐热合金 Heat-resisting alloy
		~40HRC	~50HRC	~55HRC	~68HRC						
○	○	○	○	○		○	○		○	○	



Delivery  
交货期



请咨询  
Please ask



Order  
订货范例

Code No.  
YUSB-2S001

YUSBIT

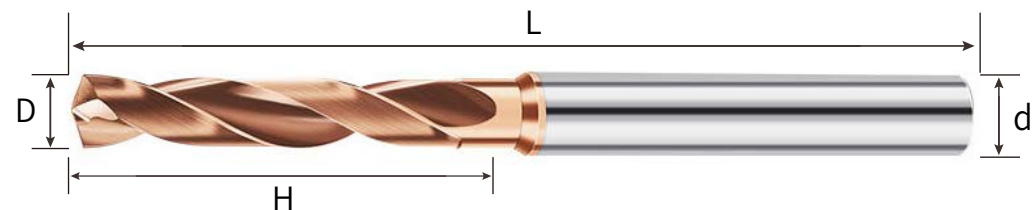

刃径	刃长	柄径	总长
D	H	d	L
2	15	2	45
2.1	15	2.1	45
2.2	15	2.2	45
2.3	15	2.3	45
2.4	15	2.4	45
2.5	15	2.5	45
2.6	15	2.6	45
2.7	15	2.7	45
2.8	15	2.8	45
2.9	15	2.9	45
3	20	3	50
3.1	20	3.1	50
3.2	20	3.2	50
3.3	20	3.3	50
3.4	20	3.4	50
3.5	20	3.5	50
3.6	20	3.6	50
3.7	20	3.7	50
3.8	20	3.8	50
3.9	20	3.9	50
4	20	4	50
4.1	20	4.1	50
4.2	20	4.2	50
4.3	20	4.3	50
4.4	20	4.4	50
4.5	20	4.5	50

刃径	刃长	柄径	总长
D	H	d	L
4.6	20	4.6	50
4.7	20	4.7	50
4.8	20	4.8	50
4.9	20	4.9	50
5	20	5	50
5.1	20	5.1	50
5.2	20	5.2	50
5.3	20	5.3	50
5.4	20	5.4	50
5.5	20	5.5	50
5.6	20	5.6	50
5.7	20	5.7	50
5.8	20	5.8	50
5.9	20	5.9	50
6	30	6	60
6.1	30	6.1	60
6.2	30	6.2	60
6.3	30	6.3	60
6.4	30	6.4	60
6.5	30	6.5	60
6.6	30	6.6	60
6.7	30	6.7	60
6.8	30	6.8	60
6.9	30	6.9	60
7	30	7	60
7.1	30	7.1	60

刃径	刃长	柄径	总长
D	H	d	L
7.2	30	7.2	60
7.3	30	7.3	60
7.4	30	7.4	60
7.5	30	7.5	60
7.6	30	7.6	60
7.7	30	7.7	60
7.8	30	7.8	60
7.9	30	7.9	60
8	40	8	75
8.1	40	8.1	75
8.2	40	8.2	75
8.3	40	8.3	75
8.4	40	8.4	75
8.5	40	8.5	75
8.6	40	8.6	75
8.7	40	8.7	75
8.8	40	8.8	75
8.9	40	8.9	75
9	40	9	75
9.1	40	9.1	75
9.2	40	9.2	75
9.3	40	9.3	75
9.4	40	9.4	75
9.5	40	9.5	75
9.6	40	9.6	75
9.7	40	9.7	75

刃径	刃长	柄径	总长
D	H	d	L
9.8	40	9.8	75
9.9	40	9.9	75
10	40	10	75
10.1	40	10.1	75
10.2	40	10.2	75
10.3	40	10.3	75
10.4	40	10.4	75
10.5	40	10.5	75
10.6	40	10.6	75
10.7	40	10.7	75
10.8	40	10.8	75
10.9	40	10.9	75
11	40	11	75
11.1	40	11.1	75
11.2	40	11.2	75
11.3	40	11.3	75
11.4	40	11.4	75
11.5	40	11.5	75
11.6	40	11.6	75
11.7	40	11.7	75
11.8	40	11.8	75
11.9	40	11.9	75
12	40	12	75

YUSBIT

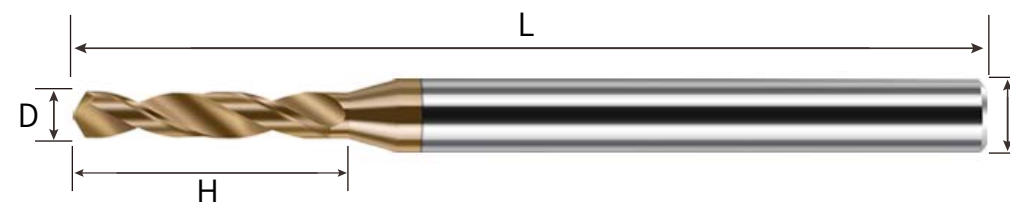

刃径	刃长	柄径	总长
D	H	d	L
0.5	4	3	38
0.55	4	3	38
0.6	5	3	38
0.65	5	3	38
0.7	5	3	38
0.75	5	3	38
0.8	5	3	38
0.85	5	3	38
0.9	5	3	38
0.95	5	3	38
1	8	3	38
1.05	8	3	38
1.1	8	3	38
1.15	8	3	38
1.2	10	3	38
1.25	10	3	38
1.3	10	3	38
1.35	10	3	38
1.4	10	3	38
1.45	10	3	38
1.5	10	3	38
1.55	10	3	38
1.6	10	3	38
1.65	10	3	38
1.7	10	3	38

刃径	刃长	柄径	总长
D	H	d	L
1.75	10	3	38
1.8	11	3	38
1.85	11	3	38
1.9	11	3	38
1.95	11	3	38
2	12	3	38
2.05	12	3	38
2.1	12	3	38
2.15	12	3	38
2.2	12	3	38
2.25	12	3	38
2.3	12	3	38
2.35	12	3	38
2.4	12	3	38
2.45	12	3	38
2.5	12	3	38
2.55	14	3	38
2.6	14	3	38
2.65	14	3	38
2.7	14	3	38
2.75	14	3	38
2.8	14	3	38
2.85	14	3	38
2.9	14	3	38
2.95	14	3	38

可切削材料适用表 Applicable table for cutting materials

非常合适 合适

碳素钢 carbon steel	合金钢 Alloy steel	预硬钢、淬硬钢 Prehardened steel, hardened steel				不锈钢 Stainless steel	铸铁 cast iron 球墨铸铁 Spheroidal graphite cast iron	铜合金 Copper alloy	铝合金 Aluminium alloy	钛合金 titanium alloy	耐热合金 Heat-resisting alloy
		~40HRC	~50HRC	~55HRC	~68HRC						
○	○	○	○	○	○	○	○	○	○	○	

Delivery 交货期 请咨询 Please ask Order 订货范例 Code No. YUSBIT-2S020

可切削材料适用表 Applicable table for cutting materials

非常合适 合适

碳素钢 carbon steel	合金钢 Alloy steel	预硬钢、淬硬钢 Prehardened steel, hardened steel				不锈钢 Stainless steel	铸铁 cast iron 球墨铸铁 Spheroidal graphite cast iron	铜合金 Copper alloy	铝合金 Aluminium alloy	钛合金 titanium alloy	耐热合金 Heat-resisting alloy
		~40HRC	~50HRC	~55HRC	~68HRC						
○	○	○	○	○	○	○	○	○	○	○	

Delivery 交货期 请咨询 Please ask Order 订货范例 Code No. YUSBIT-2S0503

YUSBIT

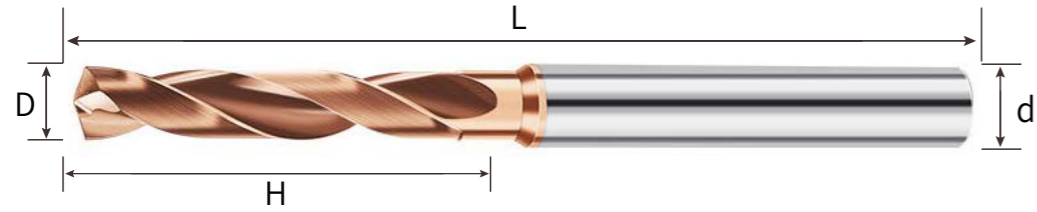

刃径	刃长	柄径	总长	刃径	刃长	柄径	总长	刃径	刃长	柄径	总长	刃径	刃长	柄径	总长
D	H	d	L	D	H	d	L	D	H	d	L	D	H	d	L
0.50	6	4	50	0.86	6	4	50	1.22	8	4	50	1.58	10	4	50
0.51	6	4	50	0.87	6	4	50	1.23	8	4	50	1.59	10	4	50
0.52	6	4	50	0.88	6	4	50	1.24	8	4	50	1.60	10	4	50
0.53	6	4	50	0.89	6	4	50	1.25	8	4	50	1.61	10	4	50
0.54	6	4	50	0.90	6	4	50	1.26	8	4	50	1.62	10	4	50
0.55	6	4	50	0.91	6	4	50	1.27	8	4	50	1.63	10	4	50
0.56	6	4	50	0.92	6	4	50	1.28	8	4	50	1.64	10	4	50
0.57	6	4	50	0.93	6	4	50	1.29	8	4	50	1.65	10	4	50
0.58	6	4	50	0.94	6	4	50	1.30	8	4	50	1.66	10	4	50
0.59	6	4	50	0.95	6	4	50	1.31	8	4	50	1.67	10	4	50
0.60	6	4	50	0.96	6	4	50	1.32	8	4	50	1.68	10	4	50
0.61	6	4	50	0.97	6	4	50	1.33	8	4	50	1.69	10	4	50
0.62	6	4	50	0.98	6	4	50	1.34	8	4	50	1.70	10	4	50
0.63	6	4	50	0.99	6	4	50	1.35	8	4	50	1.71	10	4	50
0.64	6	4	50	1.00	8	4	50	1.36	8	4	50	1.72	10	4	50
0.65	6	4	50	1.01	8	4	50	1.37	8	4	50	1.73	10	4	50
0.66	6	4	50	1.02	8	4	50	1.38	8	4	50	1.74	10	4	50
0.67	6	4	50	1.03	8	4	50	1.39	8	4	50	1.75	10	4	50
0.68	6	4	50	1.04	8	4	50	1.40	8	4	50	1.76	10	4	50
0.69	6	4	50	1.05	8	4	50	1.41	8	4	50	1.77	10	4	50
0.70	6	4	50	1.06	8	4	50	1.42	8	4	50	1.78	10	4	50
0.71	6	4	50	1.07	8	4	50	1.43	8	4	50	1.79	10	4	50
0.72	6	4	50	1.08	8	4	50	1.44	8	4	50	1.80	10	4	50
0.73	6	4	50	1.09	8	4	50	1.45	8	4	50	1.81	10	4	50
0.74	6	4	50	1.10	8	4	50	1.46	8	4	50	1.82	10	4	50
0.75	6	4	50	1.11	8	4	50	1.47	8	4	50	1.83	10	4	50
0.76	6	4	50	1.12	8	4	50	1.48	8	4	50	1.84	10	4	50
0.77	6	4	50	1.13	8	4	50	1.49	8	4	50	1.85	10	4	50
0.78	6	4	50	1.14	8	4	50	1.50	10	4	50	1.86	10	4	50
0.79	6	4	50	1.15	8	4	50	1.51	10	4	50	1.87	10	4	50
0.80	6	4	50	1.16	8	4	50	1.52	10	4	50	1.88	10	4	50
0.81	6	4	50	1.17	8	4	50	1.53	10	4	50	1.89	10	4	50
0.82	6	4	50	1.18	8	4	50	1.54	10	4	50	1.90	10	4	50
0.83	6	4	50	1.19	8	4	50	1.55	10	4	50	1.91	10	4	50
0.84	6	4	50	1.20	8	4	50	1.56	10	4	50	1.92	10	4	50
0.85	6	4	50	1.21	8	4	50	1.57	10	4	50	1.93	10	4	50

YUSBIT

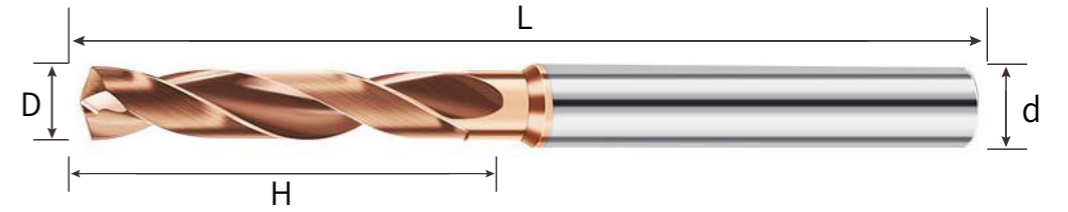

刃径	刃长	柄径	总长	刃径	刃长	柄径	总长	刃径	刃长	柄径	总长	刃径	刃长	柄径	总长	刃径	刃长	柄径	总长
D	H	d	L	D	H	d	L	D	H	d	L	D	H	d	L	D	H	d	L
1.94	10	4	50	2.30	12	4	50	2.66	15	4	50	3.02	18	4	50				
1.95	10	4	50	2.31	12	4	50	2.67	15	4	50	3.03	18	4	50				
1.96	10	4	50	2.32	12	4	50	2.68	15	4	50	3.04	18	4	50				
1.97	10	4	50	2.33	12	4	50	2.69	15	4	50	3.05	18	4	50				
1.98	10	4	50	2.34	12	4	50	2.70	15	4	50	3.06	18	4	50				
1.99	10	4	50	2.35	12	4	50	2.71	15	4	50	3.07	18	4	50				
2.00	12	4	50	2.36	12	4	50	2.72	15	4	50	3.08	18	4	50				
2.01	12	4	50	2.37	12	4	50	2.73	15	4	50	3.09	18	4	50				
2.02	12	4	50	2.38	12	4	50	2.74	15	4	50	3.10	18	4	50				
2.03	12	4	50	2.39	12	4	50	2.75	15	4	50	3.11	18	4	50				
2.04	12	4	50	2.40	12	4	50	2.76	15	4	50	3.12	18	4	50				
2.05	12	4	50	2.41	12	4	50	2.77	15	4	50	3.13	18	4	50				
2.06	12	4	50	2.42	12	4	50	2.78	15	4	50	3.14	18	4	50				
2.07	12	4	50	2.43	12	4	50	2.79	15	4	50	3.15	18	4	50				
2.08	12	4	50	2.44	12	4	50	2.80	15	4	50	3.16	18	4	50				
2.09	12	4	50	2.45	12	4	50	2.81	15	4	50	3.17	18	4	50				
2.10	12	4	50	2.46	12	4	50	2.82	15	4	50	3.18	18	4	50				
2.11	12	4	50	2.47	12	4	50	2.83	15	4	50	3.19	18	4	50				
2.12	12	4	50	2.48	12	4	50	2.84	15	4	50	3.20	18	4	50				
2.13	12	4	50	2.49	12	4	50	2.85	15	4	50	3.21	18	4	50				
2.14	12	4	50	2.50	15	4	50	2.86	15	4	50	3.22	18	4	50				
2.15	12	4	50	2.51	15	4	50	2.87	15	4	50	3.23	18	4	50				
2.16	12	4	50	2.52	15	4	50	2.88	15	4	50	3.24	18	4	50				
2.17	12	4	50	2.53	15	4	50	2.89	15	4	50	3.25	18	4	50				
2.18	12	4	50	2.54	15	4	50	2.90	15	4	50	3.26	18	4	50				
2.19	12	4	50	2.55	15	4	50	2.91	15	4	50	3.27	18	4	50				
2.20	12	4	50	2.56	15	4	50	2.92	15	4	50	3.28	18	4	50				
2.21	12	4	50	2.57	15	4	50	2.93	15	4	50	3.29	18	4	50				
2.22	12	4	50	2.58	15	4	50	2.94	15	4	50	3.30	18	4	50				
2.23	12	4	50	2.59	15	4	50	2.95	15	4	50	3.31	18	4	50				
2.24	12	4	50	2.60	15	4	50	2.96	15	4	50	3.32	18	4	50				
2.25	12	4	50	2.61	15	4	50	2.97	15	4	50	3.33	18	4	50				
2.26	12	4	50	2.62	15	4	50	2.98	15	4	50	3.34	18	4	50				
2.27	12	4	50	2.63	15	4	50	2.99	15	4	50	3.35	18	4	50				
2.28	12	4	50	2.64	15	4	50	3.00	18	4	50	3.36	18	4	50				
2.29	12	4	50	2.65	15	4	50	3.01	18	4	50	3.37	18	4	50				

YUSBIT

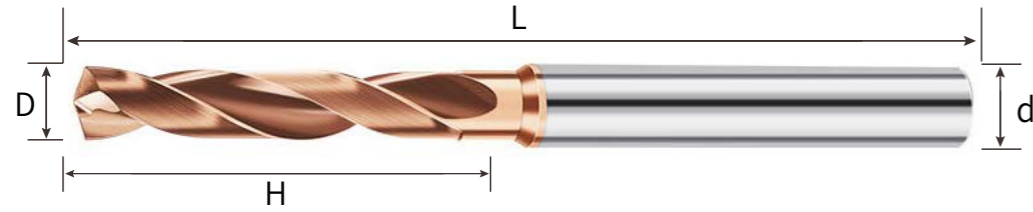

刃径 D	刃长 H	柄径 d	总长 L
3.38	18	4	50
3.39	18	4	50
3.40	18	4	50
3.41	18	4	50
3.42	18	4	50
3.43	18	4	50
3.44	18	4	50
3.45	18	4	50
3.46	18	4	50
3.47	18	4	50
3.48	18	4	50
3.49	18	4	50
3.50	20	4	50
3.51	20	4	50
3.52	20	4	50
3.53	20	4	50
3.54	20	4	50
3.55	20	4	50
3.56	20	4	50
3.57	20	4	50
3.58	20	4	50
3.59	20	4	50
3.60	20	4	50
3.61	20	4	50
3.62	20	4	50
3.63	20	4	50
3.64	20	4	50
3.65	20	4	50
3.66	20	4	50
3.67	20	4	50
3.68	20	4	50
3.69	20	4	50
3.70	20	4	50
3.71	20	4	50
3.72	20	4	50
3.73	20	4	50

刃径 D	刃长 H	柄径 d	总长 L
3.74	20	4	50
3.75	20	4	50
3.76	20	4	50
3.77	20	4	50
3.78	20	4	50
3.79	20	4	50
3.80	20	4	50
3.81	20	4	50
3.82	20	4	50
3.83	20	4	50
3.84	20	4	50
3.85	20	4	50
3.86	20	4	50
3.87	20	4	50
3.88	20	4	50
3.89	20	4	50
3.90	20	4	50
3.91	20	4	50
3.92	20	4	50
3.93	20	4	50
3.94	20	4	50
3.95	20	4	50
3.96	20	4	50
3.97	20	4	50
3.98	20	4	50
3.99	20	4	50
4.00	24	5	66
4.05	24	5	66
4.10	24	5	66
4.15	24	5	66
4.20	24	5	66
4.25	24	5	66
4.30	24	5	66
4.35	24	5	66
4.40	24	5	66
4.45	24	5	66

刃径 D	刃长 H	柄径 d	总长 L
4.50	24	5	66
4.55	24	5	66
4.60	24	5	66
4.65	24	5	66
4.70	24	5	66
4.75	24	5	66
4.80	28	5	66
4.85	28	5	66
4.90	28	5	66
4.95	28	5	66
5.00	28	6	66
5.05	28	6	66
5.10	28	6	66
5.15	28	6	66
5.20	28	6	66
5.25	28	6	66
5.30	28	6	66
5.35	28	6	66
5.40	28	6	66
5.45	28	6	66
5.50	28	6	66
5.55	28	6	66
5.60	28	6	66
5.65	28	6	66
5.70	28	6	66
5.75	28	6	66
5.80	28	6	66
5.85	28	6	66
5.90	28	6	66
5.95	28	6	66
6.00	34	7	79
6.05	34	7	79
6.10	34	7	79
6.15	34	7	79
6.20	34	7	79
6.25	34	7	79

刃径 D	刃长 H	柄径 d	总长 L
6.30	34	7	79
6.35	34	7	79
6.40	34	7	79
6.45	34	7	79
6.50	34	7	79
6.55	34	7	79
6.60	34	7	79
6.65	34	7	79
6.70	34	7	79
6.75	34	7	79
6.80	34	7	79
6.85	34	7	79
6.90	34	7	79
6.95	34	7	79
7.00	41	8	79
7.05	41	8	79
7.10	41	8	79
7.15	41	8	79
7.20	41	8	79
7.25	41	8	79
7.30	41	8	79
7.35	41	8	79
7.40	41	8	79
7.45	41	8	79
7.50	41	8	79
7.55	41	8	79
7.60	41	8	79
7.65	41	8	79
7.70	41	8	79
7.75	41	8	79
7.90	41	8	79
7.95	41	8	79
8.00	47	9	89
8.05	47	9	89

YUSBIT

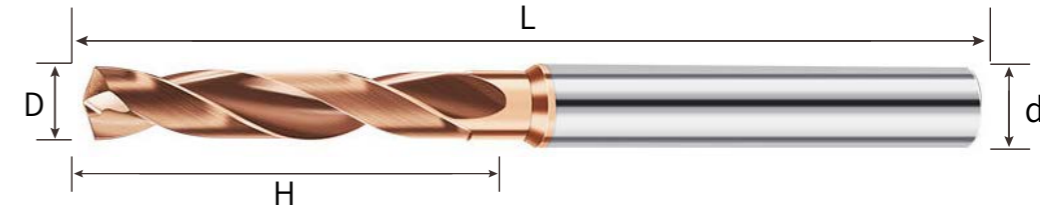

刃径 D	刃长 H	柄径 d	总长 L
8.10	47	9	89
8.15	47	9	89
8.20	47	9	89
8.25	47	9	89
8.30	47	9	89
8.35	47	9	89
8.40	47	9	89
8.45	47	9	89
8.50	47	9	89
8.55	47	9	89
8.60	47	9	89
8.65	47	9	89
8.70	47	9	89
8.75	47	9	89
8.80	47	9	89
8.85	47	9	89
8.90	47	9	89
8.95	47	9	89
9.00	47	10	89
9.05	47	10	89
9.10	47	10	89
9.15	47	10	89
9.20	47	10	89
9.25	47	10	89
9.30	47	10	89
9.35	47	10	89

刃径 D	刃长 H	柄径 d	总长 L
9.40	47	10	89
9.45	47	10	89
9.50	47	10	89
9.55	47	10	89
9.60	47	10	89
9.65	47	10	89
9.70	47	10	89
9.75	47	10	89
9.80	47	10	89
9.85	47	10	89
9.90	47	10	89
9.95	47	10	89
10.00	55	11	102
10.05	55	11	102
10.10	55	11	102
10.15	55	11	102
10.20	55	11	102
10.25	55	11	102
10.30	55	11	102
10.35	55	11	102
10.40	55	11	102
10.45	55	11	102
10.50	55	11	102
10.55	55	11	102
10.60	55	11	102
10.65	55	11	102

刃径 D	刃长 H	柄径 d	总长 L
10.70	55	11	102
10.75	55	11	102
10.80	55	11	102
10.85	55	11	102
10.90	55	11	102
10.95	55	11	102
11.00	55	12	102
11.05	55	12	102
11.10	55	12	102
11.15	55	12	102
11.20	55	12	102
11.25	55	12	102
11.30	55	12	102
11.35	55	12	102
11.40	55	12	102
11.45	55	12	102
11.50	55	12	102
11.55	55	12	102
11.60	55	12	102
11.65	55	12	102
11.70	55	12	102
11.75	55	12	102
11.80	55	12	102
11.85	55	12	102
11.90	55	12	102
11.95	55	12	102

可切削材料适用表 Applicable table for cutting materials

非常合适  合适

碳素钢 carbon steel	合金钢 Alloy steel	预硬钢、淬硬钢 Prehardened steel, hardened steel				不锈钢 Stainless steel	铸铁 cast iron 球墨铸铁 Spheroidal graphite cast iron	铜合金 Copper alloy	铝合金 Aluminium alloy	钛合金 titanium alloy	耐热合金 Heat-resisting alloy
		~40HRC	~50HRC	~55HRC	~68HRC						
<input checked="" type="radio"/>	<input checked="" type="radio"/>	<input checked="" type="radio"/>	<input checked="" type="radio"/>	<input type="radio"/>	<input type="radio"/>	<input type="radio"/>	<input type="radio"/>	<input type="radio"/>	<input type="radio"/>	<input type="radio"/>	<input type="radio"/>

Delivery 交货期  请咨询 Please ask  Order 订货范例 Code No. YUSBIT-2S005004

BT-APU

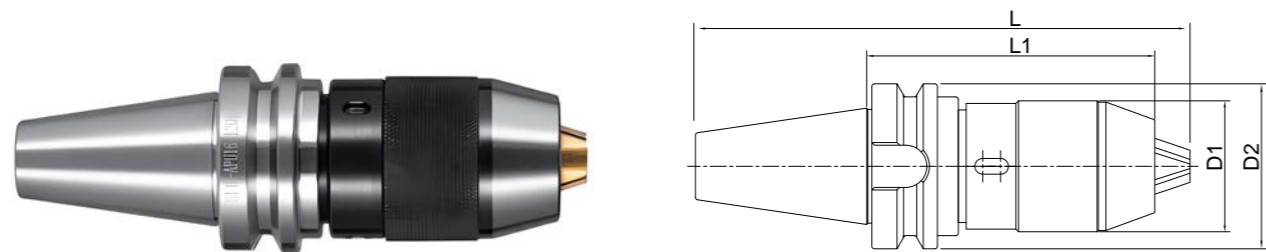

型号	夹持范围	D1	D2	L	L1
BT30-APU8-80	0.5-8	36.5	46	137.4	80
BT30-APU13-110	1-13	48	46	158.4	110
BT30-APU16-110	3-16	55.5	46	158.4	110
BT40-APU8-85	0.5-8	36.5	63	150.4	85
BT40-APU-13-110	1-13	48	63	170.4	105
BT40-APU16-120	3-16	55.5	63	195.4	130
BT50-APU13-110	1-13	48	100	211.8	110
BT50-APU13-180	1-13	48	100	281.8	180
BT50-APU16-120	3-16	55.5	100	236.8	130
BT50-APU16-180	3-16	55.5	100	296.8	190

Delivery 交货期  
 请咨询 Please ask  
 Order 订货范例  Code No.

BT-ER

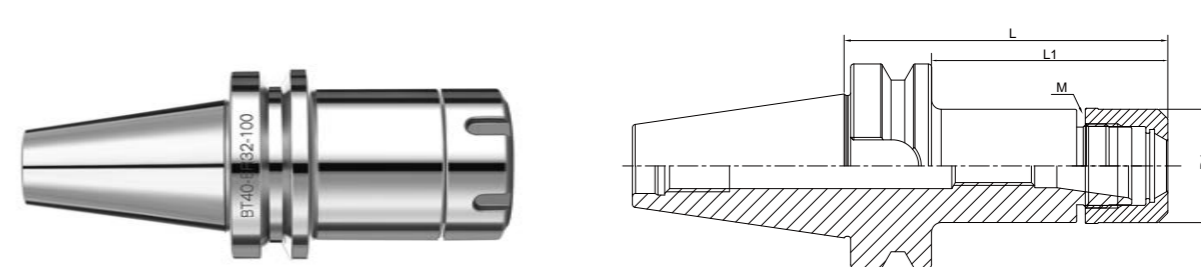

刀柄规格	名称·最大内径	尺寸 (Size)				螺帽	筒夹
		L	D	L1	M	Nut	Collet
BT30	ER16	70	28	48	M22*1.5	ER16A	ER16
		100	28	72	M22*1.5	ER16A	ER16
	ER20	70	34	48	M25*1.5	ER20A	ER20
		100	34	78	M25*1.5	ER20A	ER20
	ER25	70	42	48	M32*1.5	ER25UM	ER25
		100	42	78	M32*1.5	ER25UM	ER25
ER32	70	50	48	M40*1.5	ER32UM	ER32	
	100	50	78	M40*1.5	ER32UM	ER32	
BT40	ER16	70	28	43	M22*1.5	ER16A	ER16
		100	28	73	M22*1.5	ER16A	ER16
		150	28	123	M22*1.5	ER16A	ER16
	ER20	70	34	43	M25*1.5	ER20A	ER20
		100	34	73	M25*1.5	ER20A	ER20
		150	34	123	M25*1.5	ER20A	ER20
	ER25	70	42	43	M32*1.5	ER25UM	ER25
		100	42	73	M32*1.5	ER25UM	ER25
		150	42	123	M32*1.5	ER25UM	ER25
	ER32	70	50	43	M40*1.5	ER32UM	ER32
		100	50	73	M40*1.5	ER32UM	ER32
		150	50	123	M40*1.5	ER32UM	ER32
ER40	100	63	73	M50*1.5	ER40UM	ER40	
	150	63	123	M50*1.5	ER40UM	ER40	
	150	63	123	M50*1.5	ER40UM	ER40	
BT50	ER16	100	28	62	M22*1.5	ER16A	ER16
		150	28	112	M22*1.5	ER16A	ER16
	ER20	100	34	62	M25*1.5	ER20A	ER20
		150	34	112	M25*1.5	ER20A	ER20
	ER25	100	42	62	M32*1.5	ER25UM	ER25
		150	42	112	M32*1.5	ER25UM	ER25
	ER32	100	50	62	M40*1.5	ER32UM	ER32
		150	50	112	M40*1.5	ER32UM	ER32
	ER40	100	63	62	M50*1.5	ER40UM	ER40
		150	63	112	M50*1.5	ER40UM	ER40

Delivery 交货期  
 请咨询 Please ask  
 Order 订货范例  Code No.



BT-FMB

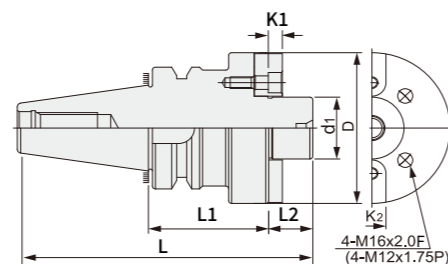

型号	D1	D	L1	L2	L
BT30-FMB22-45	22	48	45	18	111.4
BT30-FMB27-45	27	60	45	20	113.4
BT30-FMB32-45	32	78	45	22	115.4
BT40-FMB22-45	22	48	45	18	128.4
BT40-FMB22-60	22	48	60	18	143.4
BT40-FMB22-100	22	48	100	18	183.4
BT40-FMB22-150	22	48	150	18	233.4
BT40-FMB22-200	22	48	200	18	283.4
BT40-FMB22-250	22	48	250	18	283.4
BT40-FMB27-60	27	68	60	20	128.4
BT40-FMB32-60	32	78	60	22	128.4
BT40-FMB40-60L	40	80	60	25	128.4
BT50-FMB22-100	22	48	100	18	201.8
BT50-FMB22-150	22	48	150	18	269.8
BT50-FMB22-200	22	48	200	18	319.8
BT50-FMB22-250	22	48	250	18	369.8
BT50-FMB22-300	22	48	300	18	419.8
BT50-FMB22-350	22	48	350	18	469.8
BT50-FMB22-400	22	48	400	18	519.8
BT50-FMB22-450	22	48	450	18	569.8
BT50-FMB22-500	22	48	500	18	619.8
BT50-FMB27-100	27	60	100	20	201.8
BT50-FMB27-150	27	60	150	20	269.8
BT50-FMB27-200	27	60	200	20	319.8
BT50-FMB32-100	32	78	100	22	201.8
BT50-FMB32-150	32	78	150	22	269.8
BT50-FMB40-60	40	89	60	25	176.8
BT50-FMB40-100	40	89	100	25	201.8
BT50-FMB40-150	40	89	150	25	269.8
BT50-FMB60-60	60	140	60	26	161.8

BT-LBK

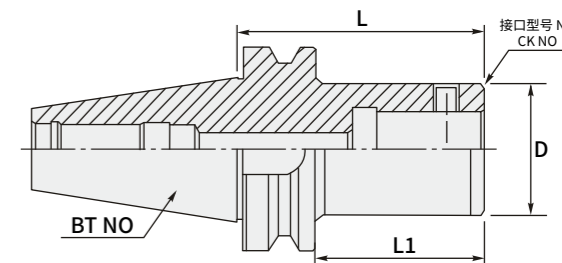

型号	接口型号	D	L	L1
BT30-LBK1-70	LBK1	19	70	40
BT30-LBK2-80	LBK2	24	80	50
BT30-LBK3-80	LBK3	31	80	50
BT30-LBK4-70	LBK4	39	70	40
BT30-LBK5-60	LBK5	50	60	30
BT30-LBK6-60	LBK6	64	60	30
BT40-LBK1-75	LBK1	19	75	40
BT40-LBK1-105	LBK1	19	105	70
BT40-LBK2-85	LBK2	24	85	50
BT40-LBK2-115	LBK2	24	115	80
BT40-LBK3-95	LBK3	31	95	60
BT40-LBK3-125	LBK3	31	125	90
BT40-LBK3-155	LBK3	39	155	120
BT40-LBK4-85	LBK4	39	85	50
BT40-LBK4-130	LBK4	49	130	65
BT40-LBK4-175	LBK4	49	175	140
BT40-LBK5-75	LBK5	62	75	40
BT40-LBK5-125	LBK5	62	125	90
BT40-LBK5-175	LBK5	62	175	140
BT40-LBK6-65	LBK6	83	65	30
BT40-LBK6-115	LBK6	19	115	90
BT40-LBK6-165	LBK6	19	165	130
BT50-LBK1-115	LBK1	24	115	65
BT50-LBK1-145	LBK1	24	145	95
BT50-LBK2-110	LBK2	31	110	70
BT50-LBK2-140	LBK2	31	140	90
BT50-LBK3-125	LBK3	39	125	95
BT50-LBK3-155	LBK3	39	155	105
BT50-LBK4-115	LBK4	49	115	65
BT50-LBK4-145	LBK4	49	145	95
BT50-LBK4-175	LBK4	62	175	125
BT50-LBK4-205	LBK4	62	205	155
BT50-LBK5-105	LBK5	62	105	55
BT50-LBK5-180	LBK5	83	180	130
BT50-LBK5-240	LBK5	83	240	90
BT50-LBK6-95	LBK6	83	95	45
BT50-LBK6-170	LBK6	83	170	145
BT50-LBK6-230	LBK6	83	230	210
BT50-LBK6-290	LBK6	83	290	145
BT50-LBK6-350	LBK6	83	350	210

交货期  
 请咨询 Please ask  
 订货范例  
 Code No. **BT30-FMB22-45**

交货期  
 请咨询 Please ask  
 订货范例  
 Code No. **BT30-LBK1-70**

BT-SK

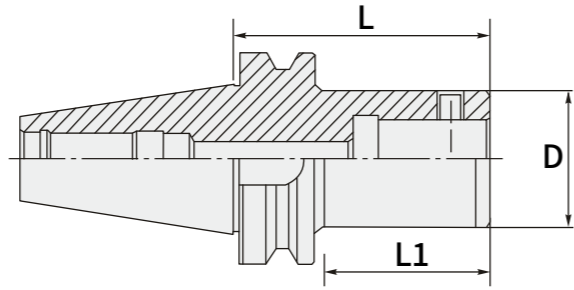

型号	夹持范围	L	L1	D	筒夹
BT30-SK6-60	2-6.0	60	38	19.5	SK6
BT30-SK6-90	2-6.0	90	68	19.5	SK6
BT30-SK10-60	2-10.0	60	38	27	SK10
BT30-SK10-90	2-10.0	90	68	27	SK10
BT30-SK-16-60	3-16.0	60	38	40	SK16
BT30-SK16-90	3-16.0	90	68	40	SK16
BT30-SK20-60	3-20.0	60	38	48	SK20
BT30-SK20-90	3-20.0	90	68	48	SK20
BT40-SK6-90	2-6.0	90	63	19.5	SK6
BT40-SK6-120	2-6.0	120	93	19.5	SK6
BT40-SK10-60	2-10.0	60	33	27	SK10
BT40-SK10-90	2-10.0	90	63	27	SK10
BT40-SK10-120	2-10.0	120	93	27	SK10
BT40-SK16-60	3-16.0	60	33	40	SK16
BT40-SK16-90	3-16.0	90	63	40	SK16
BT40-SK16-120	3-16.0	120	93	40	SK16
BT40-SK20-90	3-20.0	90	63	48	SK20
BT50-SK10-100	2-10.0	100	73	27	SK10
BT50-SK10-150	2-10.0	150	123	27	SK10
BT50-SK10-200	2-10.0	200	173	27	SK10
BT50-SK16-100	3-16.0	100	73	40	SK16
BT50-SK16-150	3-16.0	150	123	40	SK16
BT50-SK16-200	3-16.0	200	173	40	SK16

Delivery 交货期

请咨询 Please ask

Order 订货范围 Code No. BT30-SK6-60

BT-SR

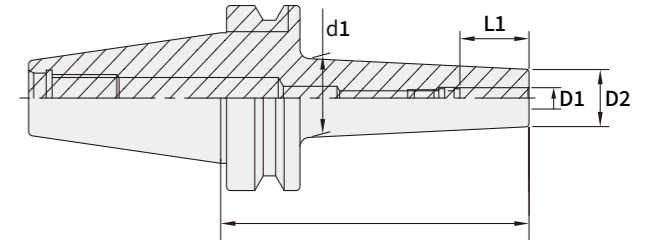

型号	d1	D1	D2	L1	L
BT30-SR4-80	15.8	4	10	10	80
BT30-SR5-80	16.8	5	11	10	80
BT30-SR6-80	17.8	6	12	10	80
BT30-SR8-80	19.8	8	14	10	80
BT30-SR10-80	21.8	10	16	26	80
BT30-SR12-80	23.8	12	18	32	80
BT30-SR14-80	25.8	14	20	38	80
BT30-SR16-90	27.8	16	22	38	90
BT30-SR20-90	31.8	20	26	42	90
BT40-SR4-90	18	4	10	10	90
BT40-SR5-90	19	5	11	10	90
BT40-SR6-90	20	6	12	10	90
BT40-SR6-120	20	6	12	10	120
BT40-SR8-90	22	8	14	10	90
BT40-SR8-120	22	8	14	10	120
BT40-SR10-90	24	10	16	26	90
BT40-SR10-120	24	10	16	26	120
BT40-SR12-90	26	12	18	32	90
BT40-SR12-120	26	12	18	32	120
BT40-SR14-90	28	14	20	38	90
BT40-SR14-120	28	14	20	38	120
BT40-SR16-90	30	16	22	38	90
BT40-SR16-120	30	16	22	38	120
BT40-SR18-95	32	18	24	40	95
BT40-SR18-120	32	18	24	40	120
BT40-SR20-95	34	20	26	42	95
BT40-SR20-120	34	20	26	42	120
BT40-SR25-120	39	25	31	50	120
BT50-SR12-130	26	12	18	32	120

Delivery 交货期

请咨询 Please ask

Order 订货范围 Code No. BT30-SR4-80

## BT-SDC

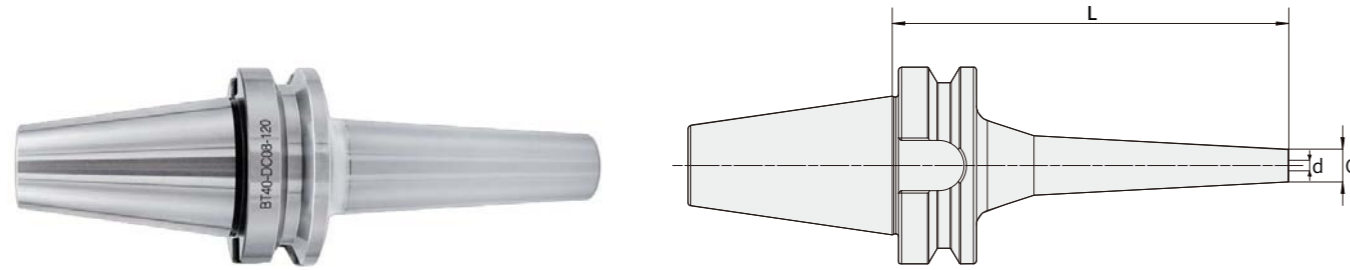

型号	D	L	C
BT30-SDC6-60	3.0-6.0	60	14.5
BT30-SDC6-90	3.0-6.0	90	14.5
BT30-SDC8-60	3.0-10.0	60	22
BT30-SDC8-90	3.0-10.0	90	22
BT40-SDC6-150	3.0-6.0	150	14.5
BT40-SDC6-200	3.0-6.0	200	14.5
BT40-SDC8-150	3.0-10.0	150	22
BT40-SDC8-200	3.0-10.0	200	22
BT40-SDC12-150	3.0-12.0	150	34
BT40-SDC12-200	3.0-12.0	200	34
BT50-SDC6-150	3.0-6.0	150	14.5
BT50-SDC6-200	3.0-6.0	200	14.5
BT50-SDC6-250	3.0-6.0	250	14.5
BT50-SDC6-300	3.0-6.0	300	14.5
BT50-SDC8-150	3.0-10.0	150	22
BT50-SDC8-200	3.0-10.0	200	22
BT50-SDC8-250	3.0-10.0	250	22
BT50-SDC8-300	3.0-10.0	300	22
BT50-SDC12-150	3.0-12.0	150	34
BT50-SDC12-200	3.0-12.0	200	34
BT50-SDC12-250	3.0-12.0	250	34
BT50-SDC12-300	3.0-12.0	300	34

## BT-M

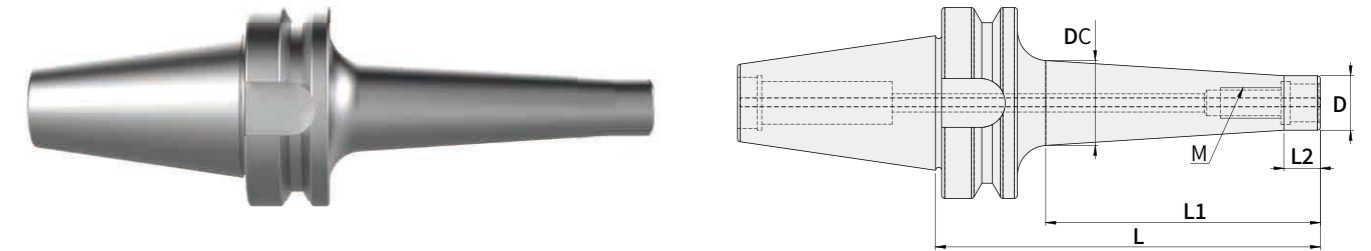

型号	M	D	DC	L	L2	L1
BT30-M8-50L	8	15	17	50	-	30
BT30-M8-100L	8	15	17	100	-	80
BT30-M10-50L	10	19	21	50	-	30
BT30-M10-100L	10	19	21	100	-	80
BT30-M12-50L	12	24	25	60	-	40
BT30-M12-100L	12	24	26	100	-	80
BT30-M16-50L	16	30	33	60	-	40
BT30-M16-100L	16	30	32	100	-	80
BT40-M8-70L	8	15	17	70	-	45
BT40-M8-100L	8	15	17	100	-	75
BT40-M8-150L	8	15	22	150	50	125
BT40-M10-70L	10	19	20	70	-	45
BT40-M10-100L	10	19	25	100	-	75
BT0-M10-150L	10	19	25	150	-	125
B140-M12-70L	12	24	26	70	-	45
BT40-M12-100L	12	24	32	100	-	75
BT40-M12-150L	12	24	37	150	50	125
BT40-M16-70L	16	30	32	70	-	45
BT40-M16-100L	16	30	36	100	30	75
BT40-M16-150L	16	30	41	150	-	125

Delivery  
交货期请咨询  
Please askOrder  
订货范例  
Code No.  
BT30-SDC6-60Delivery  
交货期请咨询  
Please askOrder  
订货范例  
Code No.  
BT30-SR4-80

35°VB/VC

● 稳定切削 ● 一般切削 ☐ 不稳定切削

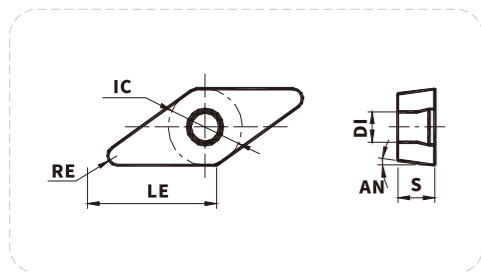

工件材料	PVD涂层									
	YU960	YU820P	YU800	YU750	YU600	YU500	YU880	YU860	YU580	
P 钢	●	●	●	●	●	●	●	●	●	●
M 不锈钢	●	●	●	●	●	●	●	●	●	●
K 铸铁			●	●	●	●	●	●	●	●
N 有色金属										
S 耐热合金、钛合金										

加工类型	刀片外形	型号	基本尺寸 (mm)						PVD涂层					CVD涂层				
			LE	IC	S	DI	RE	AN	YU960	YU820P	YU800	YU750	YU600	YU500	YU880	YU860	YU580	
半精加工		VBMT110304-TM	11	6.35	3.18	2.8	0.4	5°	★							★		
		VBMT110308-TM	11	6.35	3.18	2.8	0.8	5°	★							★		
		VBMT160404-TM	16.5	9.525	4.76	4.4	0.4	5°	★							★		
		VBMT160408-TM	16.5	9.525	4.76	4.4	0.8	5°	★							★		
		VBMT160412-TM	16.5	9.525	4.76	4.4	1.2	5°	★							★		
半精加工		VCMT110304-TM	11	6.35	3.18	2.8	0.4	7°	★						★			
		VCMT110308-TM	11	6.35	3.18	2.8	0.8	7°	★						★			
		VCMT160404-TM	16.5	9.525	4.76	4.4	0.4	7°	★						★			
		VCMT160408-TM	16.5	9.525	4.76	4.4	0.8	7°	★						★			
		VCMT160412-TM	16.5	9.525	4.76	4.4	1.2	7°	★						★			

★主推牌号 ☆可选牌号

Delivery 交货期  
 请咨询 Please ask  
 Order 订货范例  
 Code No. VBMT110304-TM-YU880

35°VN

● 稳定切削 ● 一般切削 ☐ 不稳定切削

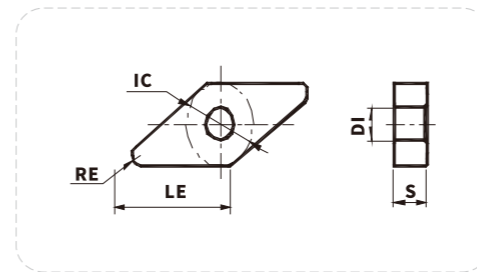

工件材料	PVD涂层									
	YU960	YU820P	YU800	YU750	YU600	YU500	YU880	YU860	YU580	
P 钢	●	●	●	●	●	●	●	●	●	●
M 不锈钢	●	●	●	●	●	●	●	●	●	●
K 铸铁			●	●	●	●	●	●	●	●
N 有色金属										
S 耐热合金、钛合金										

加工类型	刀片外形	型号	基本尺寸 (mm)					PVD涂层					CVD涂层				
			LE	IC	S	DI	RE	YU960	YU820P	YU800	YU750	YU600	YU500	YU880	YU860	YU580	
精加工		VNMG160404-GF	16.6	9.525	4.76	3.81	0.4								★		
		VNMG160408-GF	16.6	9.525	4.76	3.81	0.8								★		
精加工		VNMG160404-BF	16.6	9.525	4.76	3.81	0.4	★									
		VNMG160408-BF	16.6	9.525	4.76	3.81	0.8	★									
半精加工		VNMG160404-GT	16.6	9.525	4.76	3.81	0.4								★		
		VNMG160408-GT	16.6	9.525	4.76	3.81	0.8								★		
		VNMG160412-GT	16.6	9.525	4.76	3.81	1.2								★		
半精加工		VNMG160404-BM	16.6	9.525	4.76	3.81	0.4	★									
		VNMG160408-BM	16.6	9.525	4.76	3.81	0.4	★									
		VNMG160412-BM	16.6	9.525	4.76	3.81	0.8	★									
铸铁加工		VNMG160404	16.5	9.525	4.76	3.81	0.4										★
		VNMG160408	16.5	9.525	4.76	3.81	0.8										★
铸铁加工		VNMA160404	16.6	9.525	4.76	3.81	0.4										★
		VNMA160408	16.6	9.525	4.76	3.81	0.8										★

★主推牌号 ☆可选牌号

Delivery 交货期  
 请咨询 Please ask  
 Order 订货范例  
 Code No. VNMG160402-GF-YU880

55°DC□□

● 稳定切削 ● 一般切削 □ 不稳定切削

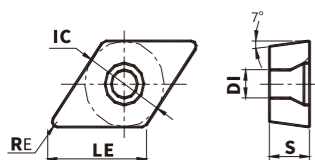

工件材料

P	钢	●	●	●	●	□	□	□	□	□	□	□	□
M	不锈钢	●	●	●	●	□	□	□	□	□	□	□	□
K	铸铁			●		□	□	□	□	□	□	□	●
N	有色金属												
S	耐热合金、钛合金												

加工类型	刀片外形	型号	基本尺寸 (mm)					PVD涂层					CVD涂层					
			LE	IC	S	DI	RE	YU960	YU820P	YU800	YU750	YU600	YU500	YU880	YU860	YU580		
精加工		DCMT070204-MP	7.8	6.35	2.38	2.8	0.4	★										
		DCMT11T304-MP	11.6	9.525	3.97	4.4	0.4	★										
		DCMT11T308-MP	11.6	9.525	3.97	4.4	0.8	★										
半精加工		DCMT070204-TM	7.8	6.35	2.38	2.8	0.4	★							★			
		DCMT070208-TM	7.8	6.35	2.38	2.8	0.8	★							★			
		DCMT11T304-TM	11.6	9.525	3.97	4.4	0.4	★							★			
		DCMT11T308-TM	11.6	9.525	3.97	4.4	0.8	★							★			
		DCMT11T312-TM	11.6	9.525	3.97	4.4	1.2	★							★			

★ 主推牌号 ☆ 可选牌号

55°DN□□

● 稳定切削 ● 一般切削 □ 不稳定切削

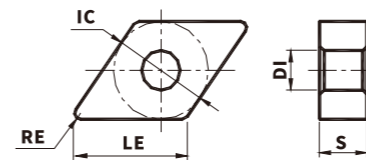

工件材料

P	钢	●	●	●	●	□	□	□	□	□	□	□	□
M	不锈钢	●	●	●	●	□	□	□	□	□	□	□	□
K	铸铁			●		□	□	□	□	□	□	□	●
N	有色金属												
S	耐热合金、钛合金												

加工类型	刀片外形	型号	基本尺寸 (mm)					PVD涂层					CVD涂层				
			LE	IC	S	DI	RE	YU960	YU820P	YU800	YU750	YU600	YU500	YU880	YU860	YU580	
精加工		DNMG150404-GF	15.5	12.7	4.76	5.16	0.4								★		
		DNMG150408-GF	15.5	12.7	4.76	5.16	0.8								★		
		DNMG150604-GF	15.5	12.7	6.35	5.16	0.4								★		
		DNMG150608-GF	15.5	12.7	6.35	5.16	0.8								★		
半精加工		DNMG150404-BF	15.5	12.7	4.76	5.16	0.4	★									
		DNMG150408-BF	15.5	12.7	4.76	5.16	0.8	★									
半精加工		DNMG150404-GT	15.5	12.7	4.76	5.16	0.4								★		
		DNMG150408-GT	15.5	12.7	4.76	5.16	0.8								★		
		DNMG150412-GT	15.5	12.7	4.76	5.16	1.2								★		
		DNMG150604-GT	15.5	12.7	6.35	5.16	0.4								★		
		DNMG150608-GT	15.5	12.7	6.35	5.16	0.8								★		
		DNMG150612-GT	15.5	12.7	6.35	5.16	1.2								★		
半精加工		DNMG150404-BM	15.5	12.7	4.76	5.16	0.4	★									
		DNMG150408-BM	15.5	12.7	4.76	5.16	0.8	★									
		DNMG150412-BM	15.5	12.7	4.76	5.16	1.2	★									
		DNMG150604-BM	15.5	12.7	6.35	5.16	0.4	★									
		DNMG150608-BM	15.5	12.7	6.35	5.16	0.8	★									
		DNMG150612-BM	15.5	12.7	6.35	5.16	1.2	★									
铸铁加工		DNMG150404	15.5	12.7	4.76	5.16	0.4										★
		DNMG150408	15.5	12.7	4.76	5.16	0.8										★
		DNMG150412	15.5	12.7	4.76	5.16	1.2										★
		DNMG150604	15.5	12.7	6.35	5.16	0.4										★
		DNMG150608	15.5	12.7	6.35	5.16	0.8										★
		DNMG150612	15.5	12.7	6.35	5.16	1.2										★
粗加工		DNMG150608-GR	15.5	12.7	6.35	5.16	0.8								★		
		DNMG150612-GR	15.5	12.7	6.35	5.16	1.2								★		
铸铁加工		DNMA150404	15.5	12.7	4.76	5.16	0.4										★
		DNMA150408	15.5	12.7	4.76	5.16	0.8										★
		DNMA150412	15.5	12.7	4.76	5.16	1.2										★
		DNMA150604	15.5	12.7	6.35	5.16	0.4										★
		DNMA150608	15.5	12.7	6.35	5.16	0.8										★
		DNMA150612	15.5	12.7	6.35	5.16	1.2										★

★ 主推牌号 ☆ 可选牌号

60°TC□□

● 稳定切削 ● 一般切削 ☐ 不稳定切削

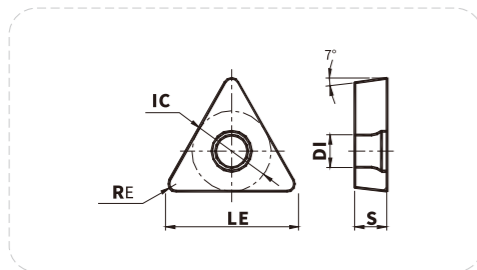

工件材料	<b>P</b> 钢	●	●	●	●	●	●	●	●	●	●	●	●	●	●	●	●	●
	<b>M</b> 不锈钢	●	●	●	●	●	●	●	●	●	●	●	●	●	●	●	●	●
	<b>K</b> 铸铁	●	●	●	●	●	●	●	●	●	●	●	●	●	●	●	●	●
	<b>N</b> 有色金属	●	●	●	●	●	●	●	●	●	●	●	●	●	●	●	●	●
	<b>S</b> 耐热合金、钛合金	●	●	●	●	●	●	●	●	●	●	●	●	●	●	●	●	●

加工类型	刀片外形	型号	基本尺寸 (mm)					PVD涂层					CVD涂层					
			LE	IC	S	DI	RE	YU960	YU820P	YU800	YU750	YU600	YU500	YU880	YU860	YU580		
精加工		TCMT16T304-MP	16.5	9.525	3.97	4.4	0.4	★										
		TCMT16T308-MP	16.5	9.525	3.97	4.4	0.8	★										
半精加工		TCMT110204-TM	11	6.35	2.38	2.8	0.4	★							★			
		TCMT110208-TM	11	6.35	2.38	2.8	0.8	★							★			
		TCMT16T304-TM	16.5	9.525	3.97	4.4	0.4	★							★			
		TCMT16T308-TM	16.5	9.525	3.97	4.4	0.8	★							★			
半精加工		TCMT16T312-TM	16.5	9.525	3.97	4.4	1.2	★							★			
		TCMT090204	9.7	5.56	2.38	2.8	0.4	★										
		TCMT110202	11	6.35	2.38	2.8	0.2	★										
		TCMT110204	11	6.35	2.38	2.8	0.4	★										
		TCMT110208	11	6.35	2.38	2.8	0.8	★										
		TCMT16T304	16.5	9.525	3.97	4.4	0.4	★										
		TCMT16T308	16.5	9.525	3.97	4.4	0.8	★										

★主推牌号 ☆可选牌号

仿形车削刀片

● 稳定切削 ● 一般切削 ☐ 不稳定切削

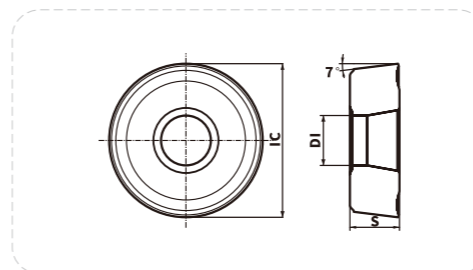

工件材料	<b>P</b> 钢	●	●	●	●	●	●	●	●	●	●	●	●	●	●	●	●	●
	<b>M</b> 不锈钢	●	●	●	●	●	●	●	●	●	●	●	●	●	●	●	●	●
	<b>K</b> 铸铁	●	●	●	●	●	●	●	●	●	●	●	●	●	●	●	●	●
	<b>N</b> 有色金属	●	●	●	●	●	●	●	●	●	●	●	●	●	●	●	●	●
	<b>S</b> 耐热合金、钛合金	●	●	●	●	●	●	●	●	●	●	●	●	●	●	●	●	●

加工类型	刀片外形	型号	基本尺寸 (mm)			PVD涂层					CVD涂层							
			IC	S	DI	YU960	YU820P	YU800	YU750	YU600	YU500	YU880	YU860	YU580				
仿形加工		RCMX1003MO	10	3.18	3.6													★
		RCMX1204MO	12	4.76	4.4													★
		RCMX1606MO	16	6.35	5.5													★
		RCMX2006MO	20	6.35	6.5													★
		RCMX2507MO	25	7.94	7.2													★
		RCMX3209MO	32	9.525	9.5													★
仿形加工		RCMX1606MO-MR	16	6.35	5.5												★	
		RCMX2006MO-MR	20	6.35	6.5												★	
		RCMX2507MO-MR	25	7.94	7.2												★	

★主推牌号 ☆可选牌号

60°TN□□

● 稳定切削 ● 一般切削 □ 不稳定切削

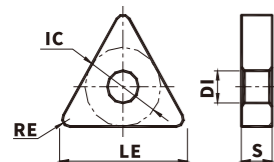

工件材料	P 钢	●	●	●	●	●	●	●	●	●	●	●	●	●	●	●	●	●
	M 不锈钢	●	●	●	●	●	●	●	●	●	●	●	●	●	●	●	●	●
	K 铸铁	●	●	●	●	●	●	●	●	●	●	●	●	●	●	●	●	●
	N 有色金属	●	●	●	●	●	●	●	●	●	●	●	●	●	●	●	●	●
	S 耐热合金、钛合金	●	●	●	●	●	●	●	●	●	●	●	●	●	●	●	●	●

加工类型	刀片外形	型号	基本尺寸 (mm)					PVD涂层					CVD涂层					
			LE	IC	S	DI	RE	YU960	YU820P	YU800	YU750	YU600	YU500	YU880	YU860	YU580		
精加工		TNMG160404-GF	16.5	9.525	4.76	3.81	0.4								★			
		TNMG160408-GF	16.5	9.525	4.76	3.81	0.8								★			
精加工		TNMG160404-BF	16.5	9.525	4.76	3.81	0.4	★										
		TNMG160408-BF	16.5	9.525	4.76	3.81	0.8	★										
半精加工		TNMG160404-GT	16.5	9.525	4.76	3.81	0.4								★			
		TNMG160408-GT	16.5	9.525	4.76	3.81	0.8								★			
		TNMG160412-GT	16.5	9.525	4.76	3.81	1.2								★			
半精加工		TNMG160404-BM	16.5	9.525	4.76	3.81	0.4	★										
		TNMG160408-BM	16.5	9.525	4.76	3.81	0.8	★										
		TNMG160412-BM	16.5	9.525	4.76	3.81	1.2	★										
半精加工		TNMG160404R-P	16.5	9.525	4.76	3.81	0.4								★			
		TNMG160404L-P	16.5	9.525	4.76	3.81	0.4								★			
		TNMG160408R-P	16.5	9.525	4.76	3.81	0.8								★			
		TNMG160408L-P	16.5	9.525	4.76	3.81	0.8								★			
半精加工		TNMG160404L-S	16.5	9.525	4.76	3.81	0.4	★										
		TNMG160404R-S	16.5	9.525	4.76	3.81	0.4	★										
		TNMG160408L-S	16.5	9.525	4.76	3.81	0.8	★										
		TNMG160408R-S	16.5	9.525	4.76	3.81	0.8	★										

★主推牌号 ☆可选牌号

60°TN□□

● 稳定切削 ● 一般切削 □ 不稳定切削

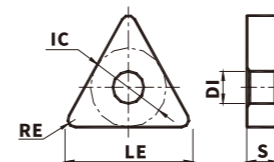

工件材料	P 钢	●	●	●	●	●	●	●	●	●	●	●	●	●	●	●	●	●
	M 不锈钢	●	●	●	●	●	●	●	●	●	●	●	●	●	●	●	●	●
	K 铸铁	●	●	●	●	●	●	●	●	●	●	●	●	●	●	●	●	●
	N 有色金属	●	●	●	●	●	●	●	●	●	●	●	●	●	●	●	●	●
	S 耐热合金、钛合金	●	●	●	●	●	●	●	●	●	●	●	●	●	●	●	●	●

加工类型	刀片外形	型号	基本尺寸 (mm)					PVD涂层					CVD涂层						
			LE	IC	S	DI	RE	YU960	YU820P	YU800	YU750	YU600	YU500	YU880	YU860	YU580			
铸铁加工		TNMG160404	16.5	9.525	4.76	3.81	0.4											★	
		TNMG160408	16.5	9.525	4.76	3.81	0.8											★	
		TNMG160412	16.5	9.525	4.76	3.81	1.2											★	
		TNMG220408	22	12.7	4.76	5.16	0.8												★
		TNMG220412	22	12.7	4.76	5.16	1.2												★
		TNMG220416	22	12.7	4.76	5.16	1.6												★
粗加工		TNMG160408-GR	16.5	9.525	4.76	3.81	0.8									★			
		TNMG160412-GR	16.5	9.525	4.76	3.81	1.2									★			
粗加工		TNMG160408-BR	16.5	9.525	4.76	3.81	0.8	★											
		TNMG160412-BR	16.5	9.525	4.76	3.81	1.2	★											
铸铁加工		TNMA160404	16.5	9.525	4.76	3.81	0.4											★	
		TNMA160408	16.5	9.525	4.76	3.81	0.8											★	
		TNMA160412	16.5	9.525	4.76	3.81	1.2											★	
		TNMA220408	22	12.7	4.76	5.16	0.8												★
		TNMA220412	22	12.7	4.76	5.16	1.2												★
		TNMA220416	22	12.7	4.76	5.16	1.6												★

★主推牌号 ☆可选牌号

80°CC□□

● 稳定切削 ● 一般切削 □ 不稳定切削

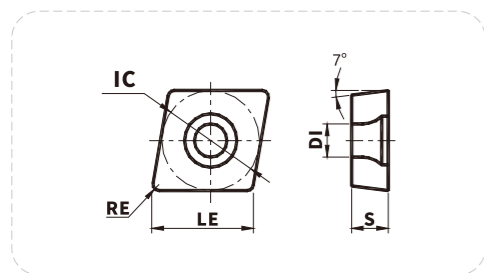

工件材料	P 钢		●	●	●	●	●	●	●	●	●	●	●
	M 不锈钢	●	●	●	●	●	●	●					
	K 铸铁		●	●	●	●	●					●	●
	N 有色金属												
	S 耐热合金、钛合金												

加工类型	刀片外形	型号	基本尺寸 (mm)					PVD涂层					CVD涂层				
			LE	IC	S	DI	RE	YU960	YU820P	YU800	YU750	YU600	YU500	YU880	YU860	YU580	
精加工		CCMT060204-MP	6.4	6.35	2.38	2.8	0.4	★							★		
		CCMT060208-MP	6.4	6.35	2.38	2.8	0.8	★							★		
		CCMT09T302-MP	9.7	9.525	3.97	4.4	0.2	★							★		
		CCMT09T304-MP	9.7	9.525	3.97	4.4	0.4	★							★		
		CCMT09T308-MP	9.7	9.525	3.97	4.4	0.8	★							★		
		CCMT120404-MP	12.9	12.7	4.76	5.56	0.4	★							★		
半精加工		CCMT120408-MP	12.9	12.7	4.76	5.56	0.8	★						★			
		CCMT060204-TM	6.4	6.35	2.38	2.8	0.4	★							★		
		CCMT060208-TM	6.4	6.35	2.38	2.8	0.8	★							★		
		CCMT09T304-TM	9.7	9.525	3.97	4.4	0.4	★							★		
		CCMT09T308-TM	9.7	9.525	3.97	4.4	0.8	★							★		
		CCMT120404-TM	12.9	12.7	4.76	5.56	0.4	★							★		
半精加工		CCMT120408-TM	12.9	12.7	4.76	5.56	0.8	★						★			
		CCMT120412-TM	12.9	12.7	4.76	5.56	1.2	★						★			

★主推牌号 ☆可选牌号

90°SC□□

● 稳定切削 ● 一般切削 □ 不稳定切削

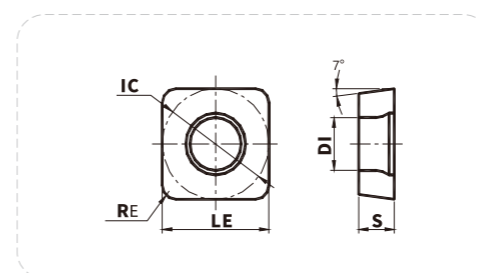

工件材料	P 钢		●	●	●	●	●	●	●	●	●	●	●
	M 不锈钢	●	●	●	●	●	●	●	●	●			
	K 铸铁		●	●	●	●	●	●					●
	N 有色金属												
	S 耐热合金、钛合金												

加工类型	刀片外形	型号	基本尺寸 (mm)					PVD涂层					CVD涂层			
			LE	IC	S	DI	RE	YU960	YU820P	YU800	YU750	YU600	YU500	YU880	YU860	YU580
精加工		SCMT09T304-MP	9.525	9.525	3.97	4.4	0.4	★								
		SCMT09T308-MP	9.525	9.525	3.97	4.4	0.8	★								
粗加工		SCMT09T304-TM	9.525	9.525	3.97	4.4	0.4	★							★	
		SCMT09T308-TM	9.525	9.525	3.97	4.4	0.8	★							★	
		SCMT120404-TM	12.7	12.7	4.76	5.56	0.4	★							★	
		SCMT120408-TM	12.7	12.7	4.76	5.56	0.8	★							★	
粗加工		SCMT120412-TM	12.7	12.7	4.76	5.56	1.2	★							★	

★主推牌号 ☆可选牌号



80°WN□□

● 稳定切削 ● 一般切削 □ 不稳定切削

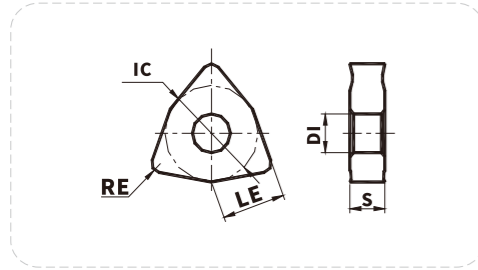

工件材料	P 钢	●	●	●	●	●	●	●	●	●	●	●	●	●	●	●	●
	M 不锈钢	●	●	●	●	●	●	●	●	●	●	●	●	●	●	●	●
	K 铸铁	●	●	●	●	●	●	●	●	●	●	●	●	●	●	●	●
	N 有色金属	●	●	●	●	●	●	●	●	●	●	●	●	●	●	●	●
	S 耐热合金、钛合金	●	●	●	●	●	●	●	●	●	●	●	●	●	●	●	●

加工类型	刀片外形	型号	基本尺寸 (mm)					PVD涂层					CVD涂层				
			LE	IC	S	DI	RE	YU960	YU820P	YU800	YU750	YU600	YU500	YU880	YU860	YU580	
精加工		WNMG060408-GF	6.6	9.525	4.76	3.81	0.8								★		
		WNMG080404-GF	8.7	12.7	4.76	5.16	0.4								★		
		WNMG080408-GF	8.7	12.7	4.76	5.16	0.8								★		
精加工		WNMG080404-BF	8.7	12.7	4.76	5.16	0.4	★									
		WNMG080408-BF	8.7	12.7	4.76	5.16	0.8	★									
半精加工		WNMG080404-GT	8.7	12.7	4.76	5.16	0.4								★		
		WNMG080408-GT	8.7	12.7	4.76	5.16	0.8								★		
		WNMG080404-GT	8.7	12.7	4.76	5.16	1.2								★		
半精加工		WNMG080404R-P	8.7	12.7	4.76	5.16	0.4								★		
		WNMG080404L-P	8.7	12.7	4.76	5.16	0.4								★		
		WNMG080408R-P	8.7	12.7	4.76	5.16	0.8								★		
		WNMG080408L-P	8.7	12.7	4.76	5.16	0.8								★		
半精加工		WNMG06T312-BM	6.6	9.525	3.97	3.81	1.2	★									
		WNMG060412-BM	6.6	9.525	4.76	3.81	1.2	★									
		WNMG080404-BM	8.7	12.7	4.76	5.16	0.4	★									
		WNMG080408-BM	8.7	12.7	4.76	5.16	0.8										
		WNMG080412-BM	8.7	12.7	4.76	5.16	1.2										

★主推牌号 ☆可选牌号

80°WN□□

● 稳定切削 ● 一般切削 □ 不稳定切削

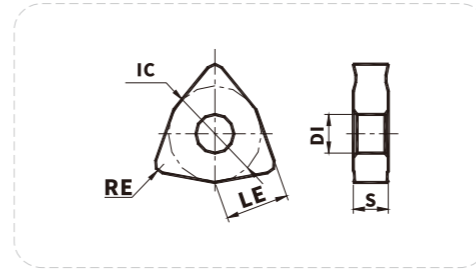

工件材料	P 钢	●	●	●	●	●	●	●	●	●	●	●	●	●	●	●	●
	M 不锈钢	●	●	●	●	●	●	●	●	●	●	●	●	●	●	●	●
	K 铸铁	●	●	●	●	●	●	●	●	●	●	●	●	●	●	●	●
	N 有色金属	●	●	●	●	●	●	●	●	●	●	●	●	●	●	●	●
	S 耐热合金、钛合金	●	●	●	●	●	●	●	●	●	●	●	●	●	●	●	●

加工类型	刀片外形	型号	基本尺寸 (mm)					PVD涂层					CVD涂层					
			LE	IC	S	DI	RE	YU960	YU820P	YU800	YU750	YU600	YU500	YU880	YU860	YU580		
粗加工		WNMG080408-GR	8.7	12.7	4.76	5.16	0.8									★		
		WNMG080412-GR	8.7	12.7	4.76	5.16	1.2									★		
粗加工		WNMG080408-BR	8.7	12.7	4.76	5.16	0.8	★										
		WNMG080412-BR	8.7	12.7	4.76	5.16	1.2	★										
铸铁加工		WNMG080404	8.7	12.7	4.76	5.16	0.4											★
		WNMG080408	8.7	12.7	4.76	5.16	0.8											★
		WNMG080412	8.7	12.7	4.76	5.16	1.2											★
粗加工		WNMA060404	6.6	9.525	4.76	3.81	0.4											★
		WNMA060408	6.6	9.525	4.76	3.81	0.8											★
		WNMA080404	8.7	12.7	4.76	5.16	0.4											★
		WNMA080416	8.7	12.7	4.76	5.16	1.6											★

★主推牌号 ☆可选牌号

80°CN□□

● 稳定切削 ● 一般切削 ■ 不稳定切削

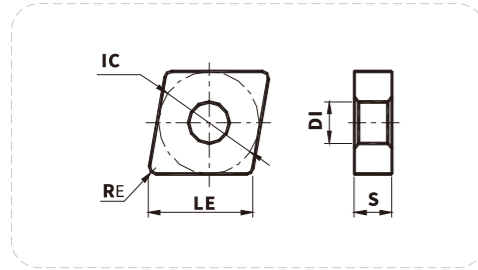

工件材料	P	钢	●	●	●	●	●	●	●	●	●	●	●	●	●
	M	不锈钢	●	●	●	●	●	●	●	●	●	●	●	●	●
	K	铸铁	●	●	●	●	●	●	●	●	●	●	●	●	●
	N	有色金属	●	●	●	●	●	●	●	●	●	●	●	●	●
	S	耐热合金、钛合金	●	●	●	●	●	●	●	●	●	●	●	●	●

加工类型	刀片外形	型号	基本尺寸 (mm)					PVD涂层					CVD涂层				
			LE	IC	S	DI	RE	YU960	YU820P	YU800	YU750	YU600	YU500	YU880	YU860	YU580	
精加工		CNMG120404-GF	12.9	12.7	4.76	5.16	0.4									★	
		CNMG120408-GF	12.9	12.7	4.76	5.16	0.8									★	
精加工		CNMG120404-BF	12.9	12.7	4.76	5.16	0.4	★									
		CNMG120408-BF	12.9	12.7	4.76	5.16	0.8	★									
半精加工		CNMG120404-GT	12.9	12.7	4.76	5.16	0.4									★	
		CNMG120408-GT	12.9	12.7	4.76	5.16	0.8									★	
		CNMG120412-GT	12.9	12.7	4.76	5.16	1.2									★	
半精加工		CNMG120404R-P	12.9	12.7	4.76	5.16	0.4									★	
		CNMG120404L-P	12.9	12.7	4.76	5.16	0.4									★	
		CNMG120408R-P	12.9	12.7	4.76	5.16	0.8									★	
		CNMG120408L-P	12.9	12.7	4.76	5.16	0.8									★	
半精加工		CNMG120404-MS	12.9	12.7	4.76	5.16	0.4	★									
		CNMG120408-MS	12.9	12.7	4.76	5.16	0.8	★									
粗加工		CNMG120408-GR	12.9	12.7	4.76	5.16	0.8									★	
		CNMG120412-GR	12.9	12.7	4.76	5.16	1.2									★	
		CNMG190608-GR	19.3	19.05	6.35	7.94	0.8									★	
		CNMG190612-GR	19.3	19.05	6.35	7.94	1.2									★	
		CNMG190616-GR	19.3	19.05	6.35	7.94	1.6									★	
粗加工		CNMG120408-BR	12.9	12.7	4.76	5.16	0.8	★									
		CNMG120412-BR	12.9	12.7	4.76	5.16	1.2	★									
		CNMG190616-BR	19.3	19.05	6.35	7.94	1.6	★									

★主推牌号 ☆可选牌号

80°CN□□

● 稳定切削 ● 一般切削 ■ 不稳定切削

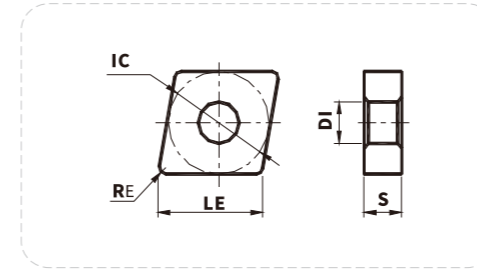

工件材料	P	钢	●	●	●	●	●	●	●	●	●	●	●	●	●
	M	不锈钢	●	●	●	●	●	●	●	●	●	●	●	●	●
	K	铸铁	●	●	●	●	●	●	●	●	●	●	●	●	●
	N	有色金属	●	●	●	●	●	●	●	●	●	●	●	●	●
	S	耐热合金、钛合金	●	●	●	●	●	●	●	●	●	●	●	●	●

加工类型	刀片外形	型号	基本尺寸 (mm)					PVD涂层					CVD涂层				
			LE	IC	S	DI	RE	YU960	YU820P	YU800	YU750	YU600	YU500	YU880	YU860	YU580	
粗加工		CNMG120404	12.9	12.7	4.76	5.16	0.4										★
		CNMA120408	12.9	12.7	4.76	5.16	0.8										★
		CNMA120412	12.9	12.7	4.76	5.16	1.2										★
		CNMA120416	12.9	12.7	4.76	5.16	1.6										★
		CNMA160608	16.1	15.875	6.35	6.35	0.8										★
		CNMA160612	16.1	15.875	6.35	6.35	1.2										★
		CNMA160616	16.1	15.875	6.35	6.35	1.6										★
		CNMA190612	19.3	19.05	6.35	7.94	1.2										★
		CNMA190616	19.3	19.05	6.35	7.94	1.6										★
重力加工		CNMM190608-GX	19.3	19.05	6.35	7.94	0.8									★	
		CNMM190612-GX	19.3	19.05	6.35	7.94	1.2									★	
		CNMM190616-GX	19.3	19.05	6.35	7.94	1.6									★	
		CNMM190624-GX	19.3	19.05	6.35	7.94	2.4									★	
		CNMM250716-GX	25.19	25.4	7.94	9.12	1.6									★	
		CNMM250724-GX	25.19	25.4	7.94	9.12	2.4									★	
		CNMM250916-GX	25.19	25.4	9.525	9.12	1.6									★	
		CNMM250924-GX	25.19	25.4	9.525	9.12	2.4									★	
		CNMM250932-GX	25.19	25.4	9.525	9.12	3.2									★	

★主推牌号 ☆可选牌号

90°SN

● 稳定切削 ● 一般切削 □ 不稳定切削

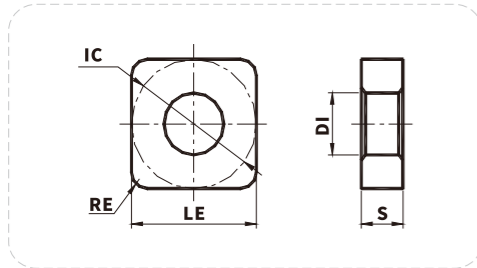

工件材料	<b>P</b> 钢		●	●	●	●	●	●	●	●	●	●	●	●
	<b>M</b> 不锈钢	●	●	●	●	●	●	●	●	●	●	●	●	●
	<b>K</b> 铸铁			●				●	●	●	●	●	●	●
	<b>N</b> 有色金属													
	<b>S</b> 耐热合金、钛合金													

加工类型	刀片外形	型号	基本尺寸 (mm)					PVD涂层					CVD涂层				
			LE	IC	S	DI	RE	YU960	YU820P	YU800	YU750	YU600	YU500	YU880	YU860	YU580	
精加工		SNMG120404-GF	12.7	12.7	4.76	5.16	0.4								★		
		SNMG120408-GF	12.7	12.7	4.76	5.16	0.8								★		
精加工		SNMG120404-BF	12.7	12.7	4.76	5.16	0.4	★									
		SNMG120408-BF	12.7	12.7	4.76	5.16	0.8	★									
半精加工		SNMG120404-GT	12.7	12.7	4.76	5.16	0.4								★		
		SNMG120408-GT	12.7	12.7	4.76	5.16	0.4								★		
		SNMG120412-GT	12.7	12.7	4.76	5.16	0.8								★		
半精加工		SNMG120404R-P	12.7	12.7	4.76	5.16	0.4								★		
		SNMG120404L-P	12.7	12.7	4.76	5.16	0.4								★		
		SNMG120408R-P	12.7	12.7	4.76	5.16	0.8								★		
		SNMG120408L-P	12.7	12.7	4.76	5.16	0.8								★		
半精加工		SNMG120404-BM	12.7	12.7	4.76	5.16	0.4	★									
		SNMG120408-BM	12.7	12.7	4.76	5.16	0.8	★									
		SNMG120412-BM	12.7	12.7	4.76	5.16	1.2	★									
粗加工		SNMG120408-GR	12.7	12.7	4.76	5.16	0.8								★		
		SNMG120412-GR	12.7	12.7	4.76	5.16	1.2								★		
		SNMG190608-GR	19.05	19.05	6.35	7.94	0.8								★		
		SNMG190612-GR	19.05	19.05	6.35	7.94	1.2								★		
		SNMG190616-GR	19.05	19.05	6.35	7.94	1.6								★		
粗加工		SNMG120408-BR	12.7	12.7	4.76	5.16	0.8	★									
		SNMG120412-BR	12.7	12.7	4.76	5.16	1.2	★									

★主推牌号 ☆可选牌号

90°SN

● 稳定切削 ● 一般切削 □ 不稳定切削

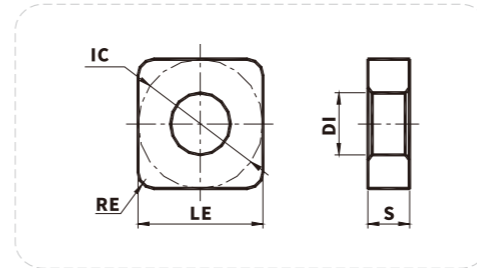

工件材料	<b>P</b> 钢		●	●	●	●	●	●	●	●	●	●	●	●
	<b>M</b> 不锈钢	●	●	●	●	●	●	●	●	●	●	●	●	●
	<b>K</b> 铸铁			●				●	●	●	●	●	●	●
	<b>N</b> 有色金属													
	<b>S</b> 耐热合金、钛合金													

加工类型	刀片外形	型号	基本尺寸 (mm)					PVD涂层					CVD涂层				
			LE	IC	S	DI	RE	YU960	YU820P	YU800	YU750	YU600	YU500	YU880	YU860	YU580	
重力加工		SNMM190608-GX	19.05	19.05	6.35	7.94	0.8										★
		SNMM190612-GX	19.05	19.05	6.35	7.94	1.2										★
		SNMM190616-GX	19.05	19.05	6.35	7.94	1.6										★
		SNMM190624-GX	19.05	19.05	6.35	7.94	2.4										★
		SNMM250716-GX	25.4	25.4	7.94	9.12	1.6										★
		SNMM250724-GX	25.4	25.4	7.94	9.12	2.4										★
		SNMM250732-GX	25.4	25.4	7.94	9.12	3.2										★
		SNMM250916-GX	25.4	25.4	9.525	9.12	1.6										★
		SNMM250924-GX	25.4	25.4	9.525	9.12	2.4										★
		SNMM250932-GX	25.4	25.4	9.525	9.12	3.2										★
铸铁加工		SNMG120404	12.7	12.7	4.76	5.16	0.4										★
		SNMG120408	12.7	12.7	4.76	5.16	0.8										★
		SNMG120412	12.7	12.7	4.76	5.16	1.2										★
		SNMG150608	15.875	15.875	6.35	6.35	0.8										★
		SNMG150612	15.875	15.875	6.35	6.35	1.2										★
		SNMG150616	15.875	15.875	6.35	6.35	1.6										★
		SNMG190612	19.05	19.05	6.35	7.94	1.2										★
SNMG190616	19.05	19.05	6.35	7.94	1.6										★		
铸铁加工		SNMA120404	12.7	12.7	4.76	5.16	0.4										★
		SNMA120408	12.7	12.7	4.76	5.16	0.8										★
		SNMA120412	12.7	12.7	4.76	5.16	1.2										★
		SNMA150608	15.875	15.875	6.35	6.35	0.8										★
		SNMA150612	15.875	15.875	6.35	6.35	1.2										★
		SNMA150616	15.875	15.875	6.35	6.35	1.6										★
		SNMA190612	19.05	19.05	6.35	7.94	1.2										★
		SNMA190616	19.05	19.05	6.35	7.94	1.6										★

★主推牌号 ☆可选牌号